

# *Getting Started with NX Open*

Update January 2019

**SIEMENS**

© 2019 Siemens Product Lifecycle Management Software Inc. All rights reserved.

Unrestricted

# Table of Contents

<b>Chapter 1: Introduction .....</b>	<b>1</b>	<b>Chapter 8: Simple Solids and Sheets .....</b>	<b>64</b>
What Is NX Open .....	1	Creating Primitive Solids .....	64
Purpose of this Guide .....	1	Sections .....	65
Where To Go From Here .....	1	Extruded Bodies .....	67
Other Documentation .....	2	Revolved Bodies .....	68
Example Code .....	3	<b>Chapter 9: Object Properties &amp; Methods .....</b>	<b>69</b>
<b>Chapter 2: Using the NX Journal Editor .....</b>	<b>4</b>	NXObject Properties .....	69
System Requirement — The .NET Framework .....	4	Curve and Edge Properties .....	71
Typographic Conventions .....	4	Face Properties .....	74
Licensing .....	4	<b>Chapter 10: Feature Concepts .....</b>	<b>76</b>
The Guide Functions .....	5	What is a Feature ? .....	76
Example 1: Hello World .....	5	Types of Features .....	76
Example 2: Collections .....	6	Feature Display Properties .....	77
Example 3: Creating Simple Geometry .....	8	Using Features and Bodies .....	78
Example 4: Reading Attributes .....	9	Units .....	78
Example 5: WinForms (The Hard Way) .....	11	Expressions .....	79
What Next? .....	14	Creating Expressions .....	81
<b>Chapter 3: Using Visual Studio Express .....</b>	<b>15</b>	Using Expressions to Define Features .....	82
Installing Visual Studio .....	15	<b>Chapter 11: Assemblies .....</b>	<b>84</b>
Installing NX Open Templates .....	16	Introduction .....	84
Licensing Issues Again .....	16	The Obligatory Car Example .....	84
Example 1: Hello World Again .....	16	Trees, Roots, and Leaves .....	84
Example 2: Declaring Variables .....	19	Components and Prototypes .....	85
Example 3: WinForms Again .....	20	Cycling Through An Assembly .....	87
Example 4: Hello World Yet Again (the Hard Way) .....	23	Indented Listings .....	88
Example 5: Editing a Recorded Journal .....	25	Component Positions & Orientations .....	88
Debugging in Visual Studio .....	28	Object Occurrences .....	89
<b>Chapter 4: The Visual Basic Language .....</b>	<b>29</b>	Creating an Assembly .....	91
The Development Process .....	29	More Advanced Positioning .....	93
Structure of a Visual Basic Program .....	29	Changing Reference Sets .....	95
An Example Program .....	30	Other Topics .....	95
Lines of Code .....	31	<b>Chapter 12: Drawings &amp; Annotations .....</b>	<b>97</b>
Built-In Data Types .....	32	Drawings .....	97
Declaring and Initializing Variables .....	32	Dimensions .....	98
Omitting Variable Declarations .....	33	Notes .....	99
Data Type Conversions .....	34	<b>Chapter 13: CAM .....</b>	<b>100</b>
Arithmetic and Math .....	34	Cycling Through CAM Objects .....	100
Logical Values & Operators .....	35	Editing CAM Objects .....	101
Arrays .....	35	CAM Views .....	102
Other Types of Collections .....	36	Creating a Tool .....	103
Strings .....	36	<b>Chapter 14: Block-Based Dialogs .....</b>	<b>104</b>
Enumerations .....	37	When to Use Block-Based Dialogs .....	104
Nothing .....	37	How Block-Based Dialogs Work .....	105
Decision Statements .....	38	The Overall Process .....	105
Looping .....	38	Using Block UI Styler .....	106
Functions and Subroutines .....	39	Template Code .....	107
Classes .....	40	The initialize_cb and dialogShown_cb Event Handlers .....	108
Shared Functions .....	41	The apply_cb Event Handler .....	108
Object Properties .....	41	The update_cb Event Handler .....	110
Hierarchy & Inheritance .....	42	Callback Details .....	111
<b>Chapter 5: Concepts &amp; Architecture .....</b>	<b>43</b>	Precedence of Values .....	111
The Levels of NX Open .....	43	Getting More Information .....	112
More About NXOpen.UF .....	43	<b>Chapter 15: Selecting NX Objects .....</b>	<b>113</b>
The NX Open Inheritance Hierarchy .....	44	Selection Dialogs .....	113
Sessions and Parts .....	44	SelectObject Blocks .....	118
Objects and Tags .....	45	Selecting Faces, Curves and Edges using Collectors .....	120
Factory Objects .....	46	Selection by Database Cycling .....	122
Object Collections .....	47	<b>Chapter 16: Exceptions .....</b>	<b>124</b>
The Builder Pattern .....	47	Exceptions .....	124
Exploring NX Open By Journaling .....	49	Example: Unhandled Exceptions .....	125
The "FindObject" Problem .....	49	Handling an Exception .....	126
Mixing SWAP and NX Open .....	50	Exception Properties .....	127
<b>Chapter 6: Positions, Vectors, and Points .....</b>	<b>52</b>	NX Exceptions .....	127
Point3d Objects .....	52	Using Undo for Error Recovery .....	128
Vector3d Objects .....	53	Avoiding Exceptions .....	128
Points .....	53	The Finally Block .....	129
<b>Chapter 7: Curves .....</b>	<b>55</b>	<b>Chapter 17: Troubleshooting .....</b>	<b>130</b>
Lines .....	55	Using the NX Log File .....	130
Associative Line Features .....	55	Invalid Attempt to Load Library .....	130
Arcs and Circles .....	56	XXX is not a member of NXOpen .....	131
Associative Arc Features .....	58	Unable to Load Referenced Library .....	132
Conic Section Curves .....	59	Visual Studio Templates Missing .....	132
Splines .....	59	Failed to Load Image .....	132
Studio Splines .....	61		
Sketches .....	62		

---

# Chapter 1: Introduction

---

## ■ What Is NX Open

NX Open is an Application Programming Interface (API) that lets you write programs to customize or extend NX. The benefit is that applications created this way can often speed up repetitive tasks, and capture important design process knowledge.

There is a broad range of NX Open functions, which provide capabilities like

- Creating part geometry, assemblies, drawings, and CAE and CAM objects
- Cycling through the objects in a part file, reading information or performing various operations on them
- Creating custom user interfaces that allow users to select objects and enter data

Some typical applications of these functions are:

- Creating part geometry or drawings according to your local standards
- Importing data from other sources, outside of NX
- Reading data from objects in a part file, and writing it out in some form of report
- Building custom applications to make processes faster or easier to understand

Of course, these are just a few examples of what is possible. You can probably think of many little repetitive processes that you would like to automate to speed up your work or standardize your output.

If you'd like a little more background information, please continue reading here. If you can't wait, and you just want to start writing code immediately, please skip to chapter 2, where we show you how to proceed.

## ■ Purpose of this Guide

This guide is a beginner's introduction to programming using NX Open. It will get you started in writing your first few applications, and give you a sample of some of the things that are possible with NX Open.

You don't need to have any programming experience to read this document, but we assume you have some basic knowledge of NX and Windows. If you are an experienced programmer, the only benefits of this document will be the descriptions of programming techniques specific to NX.

The variant of NX Open that we're describing here is just a .NET library, so it can be used with any .NET-compliant language. In this document, we focus on the Visual Basic (VB) language, but in most cases it will be obvious how to apply the same techniques in other .NET languages, such as C#, IronPython, F#, etc. Other versions of NX Open are available for use with C++, Java, and Python.

## ■ Where To Go From Here

The next two chapters show you how to write programs in two different environments. If you have no programming experience, you won't understand much of the code you see. That's OK — the purpose of these two chapters is to teach you about the programming environments and their capabilities, not about the code.

Chapter 2 discusses programming using the NX Journal Editor. The only real advantage of this environment is that it requires no setup whatsoever — you just access the Journal Editor from within NX, and you can start writing code immediately. But, by the time you reach the end of the examples in chapter 2, you will probably be growing dissatisfied with the Journal Editor, and you will want to switch to a true "Integrated Development Environment" (IDE) like Microsoft Visual Studio.

Chapter 3 discusses Microsoft Visual Studio. We explain how to download and install a free version, and how to use it to develop NX Open programs. If you have some programming experience, and you already have Visual Studio installed on your computer, you might want to skip through chapter 2 very quickly, and jump to chapter 3.

Chapter 4 provides a very quick and abbreviated introduction to the Visual Basic (VB) programming language. A huge amount of material is omitted, but you will learn enough to start writing NX Open programs in VB. If you already know Visual Basic, or you have a good book on the subject, you can skip this chapter entirely.

In Chapter 5, we provide a brief overview of NX Open concepts and architecture. It's not really necessary for you to know all of this, but understanding the underlying principles might help you to learn things more quickly.

Brief descriptions of some NX Open functions are given in chapters 6 through 15, along with examples of their uses. We focus on basic techniques and concepts, so we only describe a small subset of the available functions. You can get more complete information from the NX Open Reference Guide.

Chapter 16 discusses "exceptions", and, finally, in chapter 17, we tell you how to deal with some common problems, if they should arise.

## Other Documentation

The definitive source of information about the capabilities of NX Open is the NX Open Reference Guide, which you can find in the NX documentation set in the location shown below:

The screenshot shows the NX Open documentation website. On the left is a 'Topics' sidebar with a tree view. The 'NX Open' folder is expanded, and 'NX Open for .NET Reference Guide' is highlighted with a red box and a red arrow. The main content area is titled 'Packages' and lists various packages with brief descriptions. The 'NXOpen' package is expanded, showing sub-packages like 'AME', 'DB', 'Annotations', 'Assemblies', 'ProductInterface', 'BlockStyler', 'BodyDes', 'CAE', and 'AeroStructures'.

Package	Description
NXOpen	Provides classes and interfaces for the NX Open Com
AME	Provides classes and interfaces for AME
DB	Provides classes and interfaces for AME DB
Annotations	Provides classes and interfaces relating to Dimensions
Assemblies	Provides classes and interfaces for Assemblies
ProductInterface	Provides classes and interfaces for Assembly Product
BlockStyler	Provides classes and interfaces for Block Styler
BodyDes	Provides classes and interfaces for Body Design
CAE	Provides classes and interfaces relating to Advanced
AeroStructures	Provides classes and interfaces relating to Aero Struct

The document is fully indexed and searchable, so we hope you'll be able to find the information you need. It describes all NX Open functions in detail.

If you get tired of clicking through all the security warnings that appear when you access the NX documentation, you can fix this. In Internet Explorer, choose Tools → Internet Options → Advanced. Scroll down to the Security set of options near the bottom of the list, and check "Allow active content to run in files on My Computer".

In Visual Studio, another option is to use the Object Browser, which you can access from the View menu:

The screenshot shows the Visual Studio Object Browser. The 'Browse' dropdown is set to 'My Solution'. The search bar is empty. The tree view shows the 'HelloApp' project with the following structure:

- Microsoft.VisualBasic
- mscorlib
- NXOpen
  - NXOpen
    - ApparentChainingRule
    - ApparentChainingRuleSelection
    - ApparentChainingRuleType
    - Arc
    - ArcCollection
    - ASCImporter
    - ASCImporter.Units
    - AssembliesUtils
    - AttributeManager
    - AttributePropertiesBaseBuilder
    - AttributePropertiesBaseBuilder.BooleanValue
    - AttributePropertiesBaseBuilder.DataTypeOption
    - AttributePropertiesBaseBuilder.ObjectOption
    - AttributePropertiesBuilder

The right pane shows the 'SetParameters' method signature and its summary and parameters:

```
Public Sub SetParameters(radius As Double, center As NXOpen.Point3d, startAngle As Double, endAngle As Double, matrix As NXOpen.NXMatrix)
    Member of NXOpen.Arc

```

**Summary:**  
Sets the center, radius, start and end angles, and orientation matrix of the arc.

**Parameters:**  
*radius*: The radius must be greater than zero.  
*center*:  
*startAngle*: In radians  
*endAngle*: In radians. The end angle must not equal the start angle.

The Object Browser won't let you see the example programs and explanatory remarks that are in the Reference Guide, but it might be easier to access while you're in the middle of writing some code.

Actually, you may find that you don't need either the NX Open Reference Guide or the Visual Studio Object Browser, because all the information you need about calling a function is given by Visual Studio "intellisense" as you type.

If you have some experience with the GRIP language, then there's a document called "SNAP and NX Open for GRIP Enthusiasts" that might be helpful to you. It explains SNAP and NX Open programming in terms that are likely to be familiar to people who have used GRIP, and shows you how to map GRIP functions to SNAP and NX Open ones. You can find that document in the standard NX documentation set, in roughly the same place that you found this one.

## ■ Example Code

Once you understand the basic ideas of NX Open, you may find that code examples are the best source of help. You can find example programs in several places:

- In this guide. There are about a dozen example programs in chapters 2 and 3, along with quite detailed descriptions. Also, the later chapters contain many "snippets" of code illustrating various programming techniques.
- There are some examples in [...NX]\UGOPEN\NXOpen\Examples. There are two folders: the one called "Getting Started Examples" contains the examples from this guide, and the "More Examples" folder contains some larger examples that try to do more useful things. Here, and in the remainder of this document, the symbol [...NX] denotes the folder where the latest release of NX is installed, which is typically C:\Program Files\Siemens\NX 12, or something similar.
- The example programs accessing NX Open UI APIs are only applicable for Windows platforms.
- We will refer to user create files for Visual Studio, specifically Project and Templates. The path to this directory is Visual Studio specific. For example, [My Documents]\Visual Studio 2015\Templates\ProjectTemplates\Visual Basic holds the Visual Basic templates, and [My Documents]\Visual Studio 2015\Projects holds the user created projects. Going forward, we will refer to this directory as [My Documents]\[Visual Studio directory]. So to refer to the directory where the user create project files exist will be referenced as [My Documents]\[Visual Studio directory].
- The [GTAC web page](#) has a large collection of example programs that you can search through to find useful code. Log in with your webkey username and password. From the main menu choose "Symptom/Solution Information Query", and then "Search Solution Center". Enter a search string that includes a phrase like "sample program", and click on the "Search" button. A list of results will appear, which you can filter by document type, software product, and publish date. Set the document type filter to "nx\_api" to find sample programs, and filter further by programming language if you want to.

If you've read everything, and you're still stuck, you can contact Siemens GTAC support, or you can ask questions in the NX Customization and Programming Forum at the [Siemens PLM Community site](#).

Finally, you can often get help at [NXJournaling.com](#) and in [the NX forum at eng-tips.com](#).

# Chapter 2: Using the NX Journal Editor

In this chapter, we will discuss creation of simple programs using the NX Journal Editor. This is not a very supportive environment in which to write code, but it's OK for very simple programs, and it requires no setup. In the next chapter, we will discuss the use of Microsoft Visual Studio, instead. This requires a small preparation effort, but provides a much nicer development environment.

## ■ System Requirement — The .NET Framework

To use NX Open with NX, you need the correct version of .Net. To see what version of .Net is required please check the Release Notes of the release you are working in. It's possible that you have several versions installed (which is quite OK) — you can use the “Programs and Features” Control Panel to check:

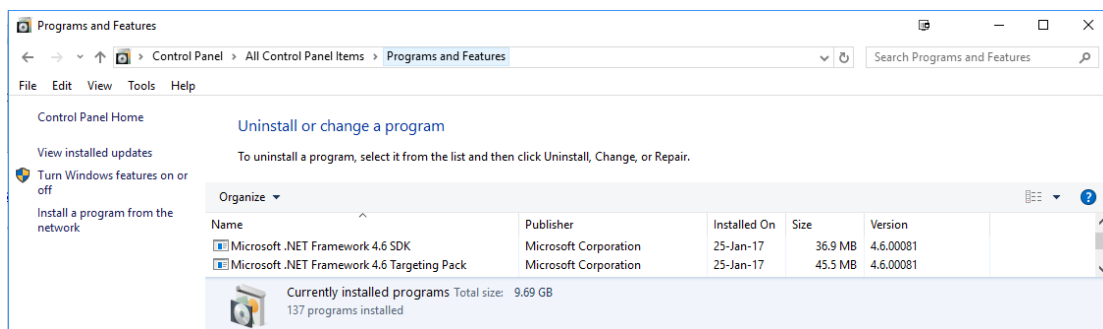

If you don't have the required version of .Net or later, please download and install it from [this Microsoft site](#). You will want to pick the .Net framework (not the .Net Core).

## ■ Typographic Conventions

In any document about programming, it's important to distinguish between text that you're supposed to read and code that you're supposed to type (which the compiler will read). In this guide, program text is either enclosed in yellowish boxes, as you see on the next page, or it's shown in [this blue font](#). References to filenames, pathnames, functions, classes, namespaces, and other computerish things will sometimes be written in [this green color](#), if this helps clarify an explanation.

## ■ Licensing

You don't require any special license to record .NET journals and play them in the NX Journal Editor, as described in this chapter. Alternatively, you can compile your journal code to produce an “executable” (an EXE or DLL file), as described in the next chapter.

Working in Journal Editor imposes some restrictions: all of your code must be in one file, and you can only call functions that reside in a small set of special libraries (the NX Open DLLs, the SNAP DLL, and a few basic Windows DLLs). If the restrictions cause trouble for you, then you can purchase an “author” license (dotnet\_author) that makes it more convenient to work with compiled code. Specifically, the author license allows you to:

- Conveniently write large compiled programs whose code is distributed across several files, and which can call any function in any .NET DLL.
- “Sign” the compiled programs you write (so that other people can run them more easily)
- Run compiled programs that call NXOpen functions, even if they have not been signed

When an NX Open program is running, it consumes licenses in the same way as an interactive NX session. So, if your NX Open program calls some drafting function, for example, then it will consume a drafting license.

## ■ The Guide Functions

There are many places where we use certain “helper” functions to make the example code in this document shorter and easier to understand. Since their only purpose is to improve the readability of this guide, we call these functions **Guide** functions. For instance, we will often need to write out text to the NX Info window. Rather than repeating the three or four lines of code required to do this, we have captured that code in the simple [Guide.InfoWriteLine](#) function. This function is used in the first example below, and in many other places.

The **Guide** functions are described in detail in an [Appendix](#), and in the NX Open Reference Guide. They are very simple and limited, because our primary goal was to make them easy to call. Though you may find uses for them in the code you write, their intended purpose is purely educational.

## ■ Example 1: Hello World

We will start by creating a journal to print “Hello World” to the NX Information Window.

Run NX, create a new part file, and then choose the **Developer** tab. If you do not see the Developer tab in the NX Ribbon bar, please activate it by selecting it from the Ribbon Bar context menu.

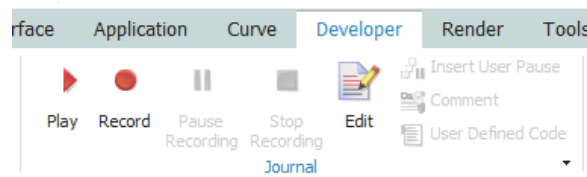

The Developer Tab contains several groups related to NX programming, including the Journal Group. The Journal Group contains commands to record, play, and edit journals, as well as some commands to add comments or code to a journal as it is recorded.

Choose Developer tab → Journal group → Edit.

In the Journal Editor dialog, Click Open in the Journal Editor toolbar and open the file [NXOpenSample.vb](#), which you can find in `[...NX]\UGOPEN\NXOpenExamples\VB\Templates`. Remember that `[...NX]` is just shorthand for the location where NX is installed, which is typically somewhere like `C:\Program Files\Siemens\NX 12`. You should see some text like this:

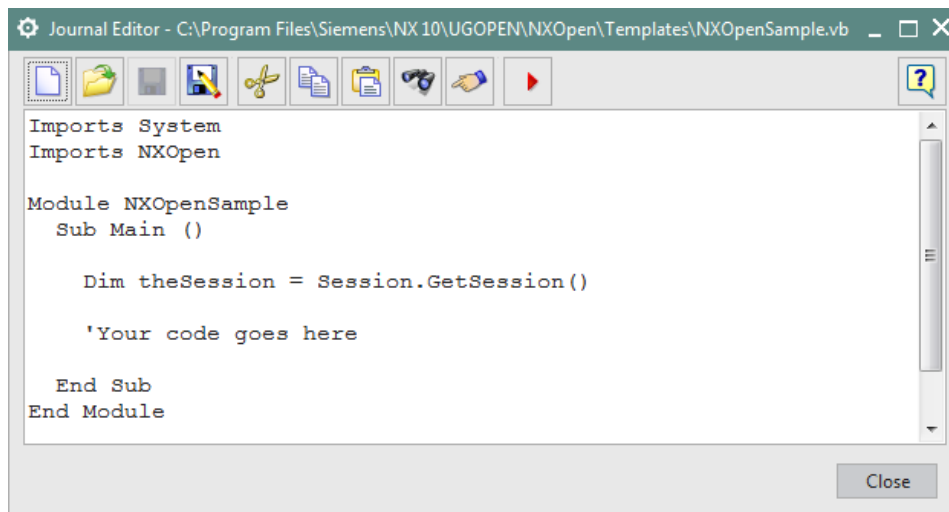

This journal just gets the NX session. Any text in a Visual Basic .NET file to the right of an apostrophe is treated as comment text by the compiler.

Now we will add some code to print “Hello World” in the NX Information Window. In your journal, replace the line of text that says `'Your code goes here` with the following line:

```
Guide.InfoWriteLine("Hello, World!")
```

In the Journal Editor, click Play, (the red triangular arrow icon) to play the journal. You should see the Information Window appear containing the text “Hello, World!”.

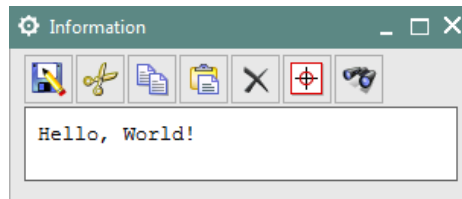

If you receive some sort of error, rather than the output shown above, here are some possible causes:

- Maybe you typed something incorrectly, in which case the compiler will probably complain that it can't understand what you wrote. An error message will tell you in which line of code the problem occurred. The description of the error might not be very helpful, but the line number should be.
- Maybe you don't have an up-to-date version of the .NET framework installed, as mentioned above. This may cause a mysterious error that reports an “Invalid attempt to load library”.
- Maybe you neglected to delete the quotation mark at the beginning of the line “Your code goes here”, in which case your code will run without any errors, but the NX Information window will not appear

There is a troubleshooting guide in [chapter 17](#) that will help you figure out what went wrong, and get it fixed. Fortunately, you will only have to go through the troubleshooting exercise once. If you can get this simple “hello world” program to work, then all the later examples should work smoothly, too.

## ■ Example 2: Collections

NX can create parts and assemblies with complex geometry and product structure. Sometimes you will need to perform operations on a collection of objects in your parts or assemblies. Using a journal to cycle through a collection will often make these tasks easier. We will start by creating some simple journals to understand how to cycle through object collections.

An NX part has several collections, each holding objects of a certain type. For example, each part has a CurveCollection that holds all the curve objects in that part. The property `workPart.Curves` accesses the CurveCollection of the work part. You can use a CurveCollection to cycle over all types of curves in an NX part. Choose File tab → Open to open the part file `curves.prt`, which you can find in `[...NX]\UGOPEN\NXOpenExamples\ExampleParts`. This part file contains several types of curves (lines, arcs, general conics, and splines) that we can cycle through to understand how collections work in NX Open.

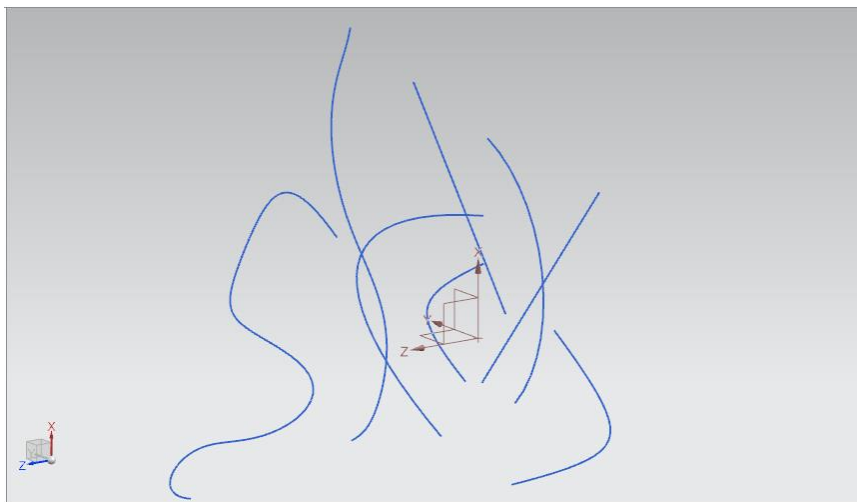

Open the file `NXOpenSample.vb` in the Journal Editor, just like the steps in example 1.



```
Imports NXOpen
Module NXJournal
  Sub Main ()
    Dim theSession = NXOpen.Session.GetSession()
    'Your code goes here
  End Sub
End Module
```

Replace the comment text `'Your code goes here` with the following lines:

```
Dim workPart = theSession.Parts.Work

Dim numCurves As Integer = 0
Dim curveLength As Double
For Each cur As curve In workPart.Curves
  numCurves = numCurves + 1
  curveLength = cur.GetLength
  Guide.InfoWriteLine("Curve " & numCurves & " has length " & curveLength)
Next cur
Guide.InfoWriteLine("Work part has " & numCurves & " curves.")
```

You can print information about each of the curves as you cycle through the curve collection. The Curve class has a method `GetLength` that returns the length of the curve. This code is cycling through the curves in the part and printing the length of each curve to the information window. Once we finish cycling through the curves, we also print out the number of curves to the information window.

The meanings of the more interesting lines of code are as follows:

Lines of code	Explanation
<code>Dim workPart = theSession.Parts.Work</code>	Declares a variable "workPart" and initializes it to the work part of the current NX session. Since we are using Option Infer On in our journals, we do not have to declare the type of this variable. The .NET Framework infers its type from the return type of the property <code>theSession.Parts.Work</code> .
<code>For Each curve In workPart.Curves</code> <code>&lt;the body of our loop&gt;</code> <code>Next curve</code>	This is a repetitive "loop" process. The statements between the "For" statement and the "Next curve" statement are executed for each curve in <code>workPart.Curves</code> , which is the CurveCollection of the work part.
<code>curveLength = curve.GetLength()</code>	Get the length of the curve by calling the <code>GetLength</code> method on the curve.
<code>Guide.InfoWriteLine</code> <code>("Work part has " &amp; numCurves &amp; " curves.")</code>	Output a line of text to the information window. The "&" character takes two strings and combines them into one. The Integer variable "numCurves" is converted to a string before it is combined with the other strings.

You should see the following output in your listing window if you used the `curves.prt` part file:

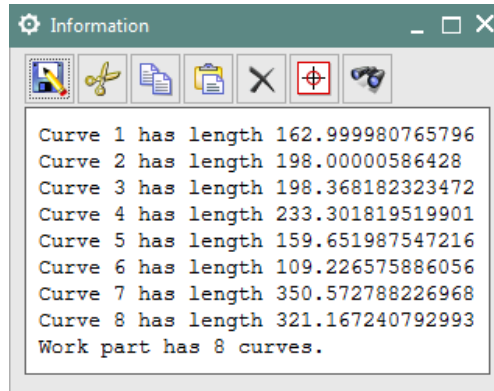

### ■ Example 3: Creating Simple Geometry

Some collections have additional methods to create objects. A `CurveCollection` has several methods for creating curves. One method, `CreateLine`, will create a line in the work part when you enter the start point and end point for the line. There are two versions of the `CreateLine` method, one that takes two point objects for the start and end points and one that takes two sets of coordinates for the start and end points.

Create a new part in NX, and then open the file `NXOpenSample.vb` in the Journal Editor just like the steps in example 1. Replace the comment text `Your code goes here` with the following lines:

```

Dim workPart = theSession.Parts.Work

Dim p1 As New Point3d(50, -100, 0)
Dim p2 As New Point3d(50, 100, 0)

Dim line1 = workPart.Curves.CreateLine(p1, p2)

Guide.InfoWriteLine("Line created with length " & line1.GetLength)
  
```

This journal creates a line from (50, -100, 0) to (50, 100, 0) with a length of 200.

The meanings of the more interesting lines of code are as follows:

Lines of code	Explanation
<code>Dim p1 As New Point3d(50, -100, 0)</code>	Declares a variable "p1" as an object of type Point3d. A Point3d is a structure that contains three double values named "X", "Y", and "Z" representing the x, y, z coordinates of the point. The coordinates are initialized to the values (50, -100, 0)
<code>Dim line1 = workPart.Curves.CreateLine(p1, p2)</code>	Create a line between "p1" and "p2" using the CreateLine method of the CurveCollection. The CurveCollection of a part is represented by the property Curves.

You can use journals to create curves programmatically in a pattern that would be difficult to do interactively in NX.

For example, the following journal creates a diagram of a parabolic mirror. It shows how rays of light are reflected off the mirror towards a focus point.

```
Dim workPart = theSession.Parts.Work
Dim vertex As New Point3d(0,0,0)
Dim focus As New Point3d(100,0,0)
Dim axisX As New Vector3d(1,0,0)
Dim axisY As New Vector3d(0,1,0)

Dim focLength = focus.X
Dim h = 100.0

Dim p1, p2 As Point3d

Dim lens = workPart.Curves.CreateParabola(vertex, axisX, axisY, focLength, -h, h)

For y = -h to h Step 10.0
  Dim x = (y*y)/(4.0*focLength)
  p1 = New Point3d(x,y,0)
  p2 = New Point3d(250,y,0)
  workPart.Curves.CreateLine(focus, p1)
  workPart.Curves.CreateLine(p1, p2)
Next y
```

Running this code should produce the following output:

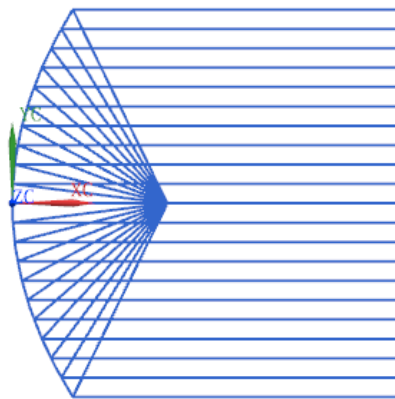

## ■ Example 4: Reading Attributes

You can attach attributes to any NX object to store information about it.

Open the part `Bracket.prt`, which you can find in `[...NX]\UGOPEN\NXOpenExamples\ExampleParts`, and then open the file `UserAttributesOnBodies.vb` in the Journal Editor just like the steps in example 1. Play the journal to see what it does:

```
Module NXJournal
  Sub Main()

    Dim theSession = Session.GetSession()

    Guide.InfoWriteLine("Outputting list of user attributes on each body in the work part:")
    Dim bodies() As Body = theSession.Parts.Work.Bodies.ToArray()
    For Each aBody As Body In bodies
      Dim attributes() As NXObject.AttributeInformation = aBody.GetUserAttributes()
      For Each attribute As NXObject.AttributeInformation In attributes
        Guide.InfoWriteLine(attribute.Title & " = " & attribute.StringValue)
      Next attribute
    Next aBody
  End Sub
End Module
```

```

Guide.InfoWriteLine("")

End Sub
End Module

```

This journal cycles through the bodies in the work part, and prints all the attributes on each body to the Information window. Attributes can be defined to be certain types, such as Integer, Number, Time, and String, but you will always be able to get a string representation of the attribute through the StringValue property.

The meanings of the more interesting lines of code are as follows:

Lines of code	Explanation
<code>Dim bodies() As Body = theSession.Parts.Work.Bodies.ToArray()</code>	Gets the BodyCollection of the work part and returns it as an array
<code>Dim attributes() As NXObject.AttributeInformation = aBody.GetUserAttributes()</code>	Get all the attributes defined on the body. The attributes are returned in an array of AttributeInformation structures.
<code>Guide.InfoWriteLine(attribute.Title &amp; " = " &amp; attribute.StringValue)</code>	Prints out the attribute title and string value of the attribute to the information window.

Running this code on [Bracket.prt](#) should produce the following Information window output:

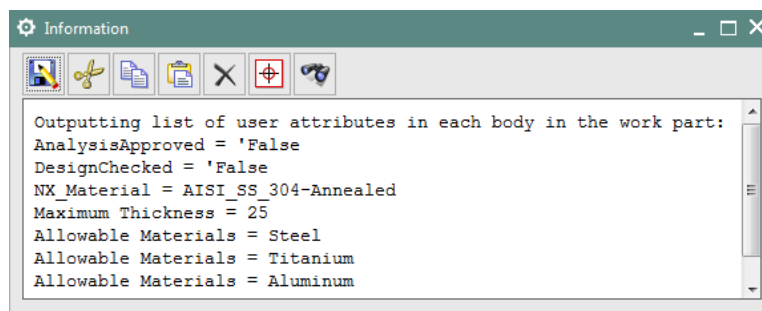

This part only has one body, so the listed attributes are from that single body. Other NX objects may have attributes attached to them. Open the journal file [UserAttributesOnGeometry.vb](#) to list any user attributes attached to bodies, faces, and edges in the work part. The journal looks like this:

```

Module NXJournal
Sub Main()

Dim theSession = Session.GetSession()

Guide.InfoWriteLine("Outputting list of user attributes on geometry in the work part:")
Dim bodies() As Body = theSession.Parts.Work.Bodies.ToArray()
For Each aBody As Body In bodies
PrintAttributes(aBody)
Dim edges = aBody.GetEdges()
For Each edg As Edge In edges
PrintAttributes(edg)
Next edg
Dim faces = aBody.GetFaces()
For Each f As Face In faces
PrintAttributes(f)
Next f

```

```

Next aBody
Guide.InfoWriteLine("")

End Sub

Sub PrintAttributes(obj As NXObject)
    Dim attributes = obj.GetUserAttributes()
    For Each attribute As NXObject.AttributeInformation In attributes
        Guide.InfoWriteLine(attribute.Title & " = " & attribute.StringValue)
    Next attribute
End Sub

End Module

```

The code that prints out the attributes of a given body might be re-usable elsewhere. To make the re-use easier, we have placed this code in a new “subroutine”, (denoted by the keyword “Sub”). We call this subroutine in our main subroutine when we want to print out the attributes for any NXObject; in our case bodies, faces, or edges. Running this code on [Bracket.prt](#) should produce the following listing window output:

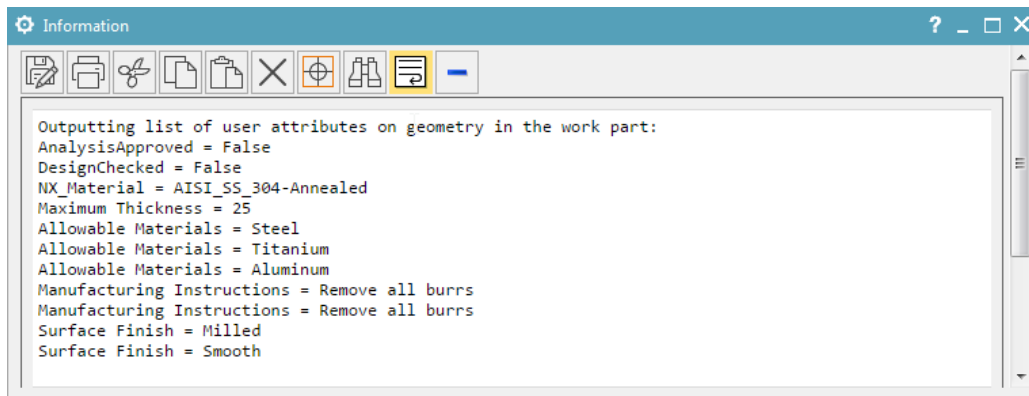

## ■ Example 5: WinForms (The Hard Way)

The .NET framework provides a wide variety of tools for designing user interface dialogs. These dialogs are called Windows Forms (WinForms, for short). The NX Block UI Styler has similar tools, and produces dialogs that are more consistent with the rest of NX, as explained in [chapter 14](#). But WinForms are more flexible, and you may find them useful in some cases. Designing WinForm-based user interfaces is actually much easier if you use an IDE like Visual Studio, and we will see how to do this in the next chapter. For now, we will create a very simple WinForm, to show the basic concepts.

Copy and Paste the following code into the file [NXOpenSample.vb](#):

```

Sub Main()
    Dim myForm As New System.Windows.Forms.Form()           'Create a Windows form
    NXOpenUI.FormUtilities.SetApplicationIcon(myForm)       'Use an NX icon for the application icon
    NXOpenUI.FormUtilities.ReparentForm(myForm)           'Set NX as the parent of our form
    myForm.BackColor = System.Drawing.Color.Red           'Color our form red
    myForm.Opacity = 0.5                                  'Make our form translucent
    myForm.Text = "Hi there"                             'Change the title of our form
    myForm.ShowDialog()                                   'Display our form
End Sub

```

When you run this application, you should see a WinForm appear, like this:

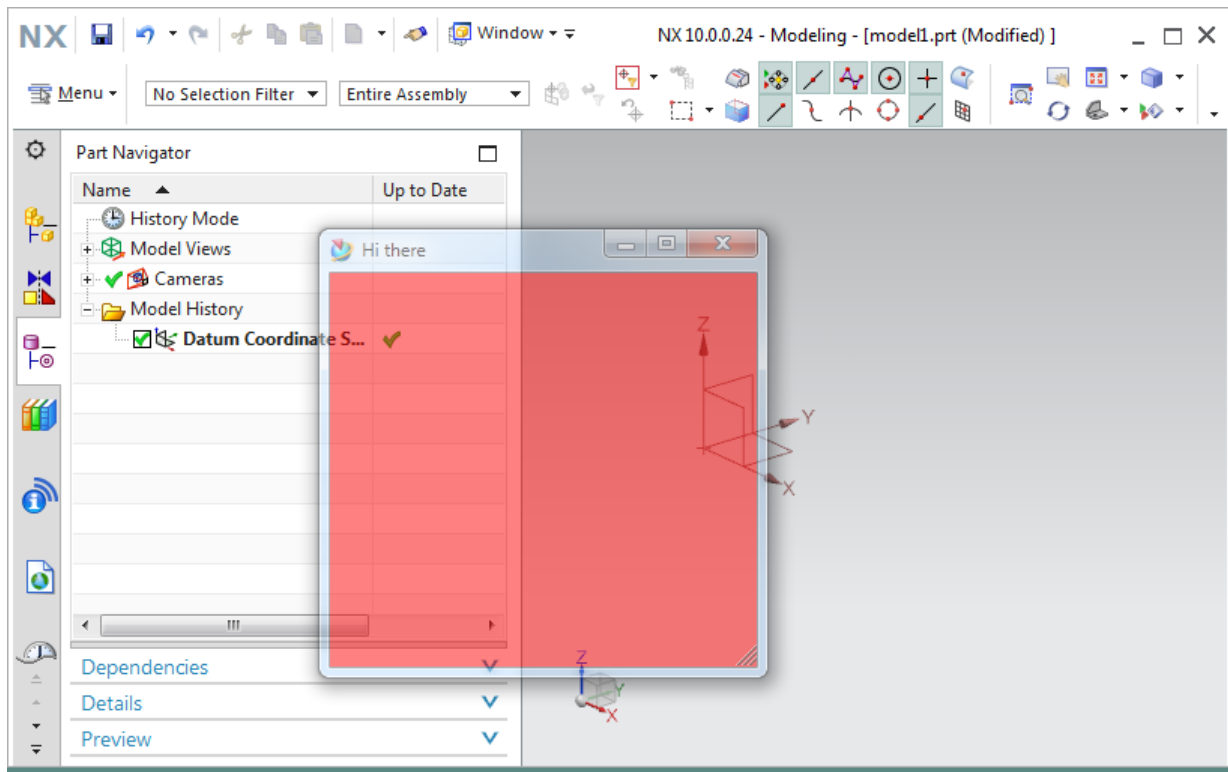

The WinForm is pretty boring, but it does have all the standard Windows functionality — you can move it around, resize it, minimize it, and so on, in the usual way. The code calls some methods in a special `FormUtilities` class in the `NXOpenUI` namespace to make our WinForm a bit more NX-specific. The method `SetApplicationIcon` creates the form with an NX icon in its top left corner, which will help the user understand that it's associated with NX. Also, the method `ReparentForm` sets the main NX Window as the “parent” of our new form, which means that our form will be minimized and restored along with the NX window, and will never get hidden underneath it. Actually, in the current scenario, our form is “modal”, which means that you have to close it before you do anything with the NX window, so the parenting arrangement doesn't have much value. We got this modal behavior because we called `myForm.ShowDialog` to display our form. There is also `myForm.Show`, which creates a non-modal form, but this doesn't work in the Journal Editor.

The next few lines of code adjust various properties of the form — we give it a red color, make it 50% transparent, and put the words “Hi there” in its title bar. There are dozens of properties that influence the appearance and behavior of a WinForm, but it's best to wait until the next chapter to explore these, because it's very easy using Visual Studio.

To stop your code running and get back to the Journal Editor, you need to close the WinForm. You do this in the usual way — click on the “X” in the top right corner.

Next, let's add a button to our WinForm. Modify the code in `NXOpenSample.vb` as follows:

```
Imports NXOpen, NXOpenUI
Imports System, System.Drawing.Color, System.Windows.Forms

Module NXOpenSample
    Dim WithEvents myButton As Button           'A variable to hold a button
    Dim theSession As Session                  'A variable to hold the NX Session
    Dim rand As Random                         'A variable to hold a random number generator

    Sub Main()
        theSession = Session.GetSession        'Get the NX Session
        rand = New Random                      'Create a random number generator
        Dim myForm As New Form                 'Create a Windows form
        myForm.Text = "Create Random Spheres"
        FormUtilities.SetApplicationIcon(myForm) 'Use an NX icon for the application icon
        FormUtilities.ReparentForm(myForm)     'Set NX as the parent of our form
        myButton = New Button                  'Create a button
        myButton.BackColor = Yellow            'Color it yellow
        myButton.Text = "Click me"            'Put some text on it
        myForm.Controls.Add(myButton)         'Add it to our form
        myForm.ShowDialog                     'Display our form
    End Sub
End Module
```

First, note that we have added another line of “Imports” statements at the top of the file. These allow us to abbreviate the names in our code. So, for example, we can refer to `Yellow` instead of the full name `System.Drawing.Color.Yellow`, and we can refer to `Random` instead of `System.Random`.

As you can see, we used the “New” keyword when creating the random number generator, the form, and the button. We didn’t use the “New” when we created NX line objects in earlier examples, and you may be wondering why these two types of objects get treated differently. The answer is given in chapter 5, in the section entitled “[Factory Objects](#)”. Don’t worry about it for now — just accept that the “New” keyword isn’t needed when you’re creating NX objects. Or, if the curiosity is overwhelming, you can read about this topic in [chapter 5](#).

Try running this code. You will see that the form is displayed, but nothing happens if you click on the yellow button. To change this, place the following code down near the bottom, just before the line that says “End Module”.

```
Sub Handler(sender As Object, e As EventArgs) Handles myButton.Click
    Dim x = 100 * rand.NextDouble             'Get a random x-coordinate between 0 and 100
    Dim y = 100 * rand.NextDouble             'Get a random y-coordinate between 0 and 100
    Dim z = 100 * rand.NextDouble             'Get a random z-coordinate between 0 and 100
    Guide.CreateSphere(x, y, z, 10)          'Create a sphere at (x,y,z) with diameter 10
End Sub
```

This is a new “subroutine” (denoted by the keyword “Sub”). So, as in the previous example, we now we have two subroutines — one called “Main” and one called “Handler”. This is a fairly typical situation — as your code gets longer, it’s easier to understand if you break it up into several subroutines.

The “Handler” function is an event handler for the “click” event of the yellow button. In other words, this code gets executed whenever you click on the yellow button in the form. As you can see, every time you click the button, the code will create a randomly-located sphere. The completed sample is in the file `CreateRandomSpheres.vb`

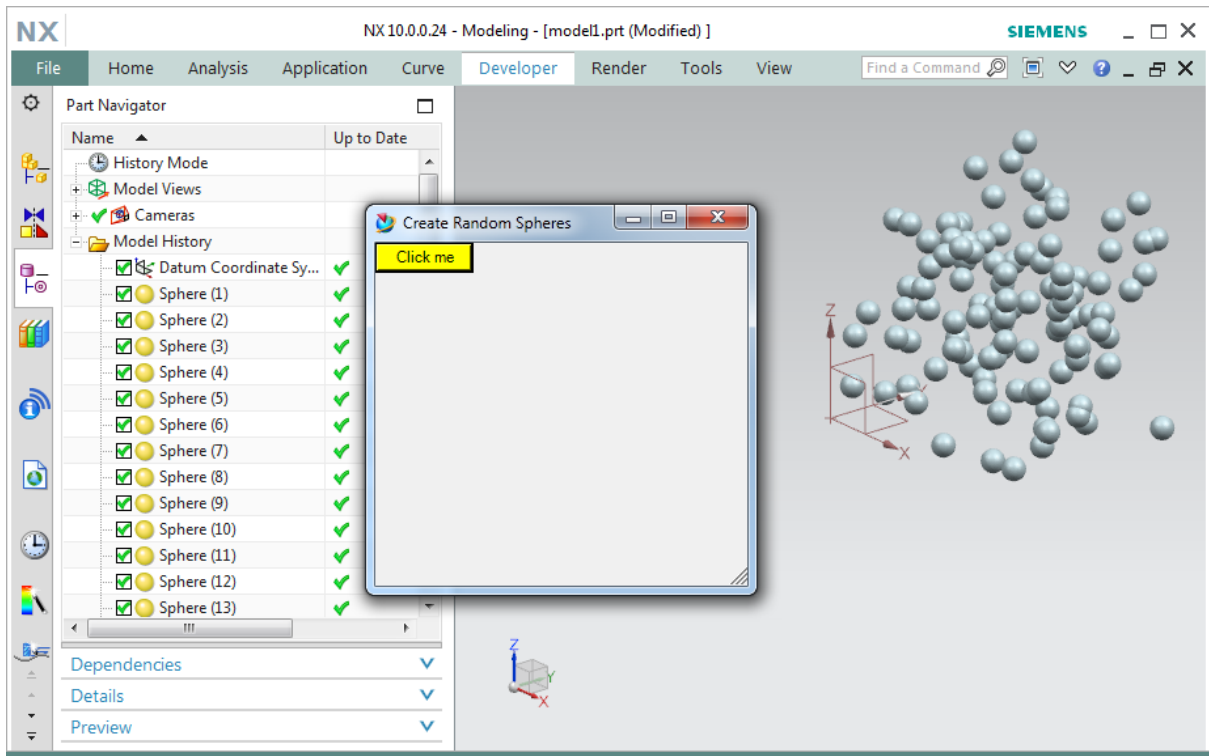

Designing buttons and writing event handlers is much easier in Visual Studio, as we will see in the next chapter.

## ■ What Next?

The examples in this chapter have given you a brief glimpse at some of the things you can do with NX Open. Using the Journal Editor, we were able to start programming immediately, and we saw that NX Open allows us to build simple user interfaces, do calculations, and create NX geometry. If you liked what you saw in this chapter, you'll probably like the next one, too. It shows you some further examples of NX Open capabilities, and also some much easier and more pleasant ways to write code.



---

# Chapter 3: Using Visual Studio Express

---

In the previous chapter, we developed code using the NX Journal Editor. This is a convenient starting point, since it requires no setup, but it is really a fairly primitive environment. Except for very short programs, it is far better to use a more powerful “integrated development environment” (IDE). Microsoft Visual Studio Express for Windows Desktop is a free-ware lightweight version of the Microsoft Visual Studio IDE used by many professional programmers. The idea, according to Microsoft, is to provide a streamlined, easy-to-use IDE for less serious users, such as hobbyists, students, and people like you. You can use this “Express” version of Visual Studio with the Visual Basic, C#, and C++ programming languages. In this chapter, we will be focusing on using Visual Basic.

**NOTE: Visual Studio Express does not allow for debugging. The full version of Visual Studio does.**

NOTE: Visual Studio and Visual Studio Express have version numbers, for example Visual Studio 2017 and Visual Studio Express 2017. The exact version of Visual Studio or Visual Studio Express is specified in the Release Notes -> Programming Tools -> NX Caveats and Product Notes -> Programming Tools -> Product Notes. The version Visual Studio that is used for the version of NX you are running in will be referred to as [Visual Studio] as opposed to Visual Studio 2017. And similar we refer to the version of Visual Studio Express as [Visual Studio Express] as opposed to Visual Studio 2017 Express.

NOTE: The NXOpen Wizards provided by NX will not work with Visual Studio Express.

## ■ Installing Visual Studio

If you already have some version of [Visual Studio] installed on your computer, and you are familiar with it, you can skip this section and proceed directly to the first example. If not, then the first step is to install [Visual Studio Express] for Windows Desktop, which you can download from [here](#), or several other places.

If you can't find the web page (because the Microsoft folks have moved it again), just search the internet for “Visual Studio Express” and include the version number (for example “2017”). Make sure you get the “for Windows Desktop” version. A common mistake is to download the “for Windows” version, instead, but this is for building Windows store apps, so it's not what we want. After selecting download, choose the executable downloaded, click next, and follow the installation instructions in order to complete the installation.

Still want Visual Studio Express?

[Express 2017 for Windows Desktop \(preview\)](#)

Supports building managed and native desktop applications.\*

[Express 2015 for Windows Desktop](#)

Supports the creation of desktop applications for Windows.

[Express 2015 for Web](#)

Create standards-based, responsive websites, web APIs, or real-time online experiences using ASP.NET.

[Express 2015 for Windows 10](#)

Provides the core tools for building compelling, innovative apps for Universal Windows Platform. Windows is required.

[Team Foundation Server 2017 Express](#)

Source-code-control, project management, and team-collaboration platform.

After you're done, you should see [Visual Studio Express] on your Programs menu, and you should see a folder called [Visual Studio Express] in your My Documents folder. For example [My Documents]\[Visual Studio] could be [My Documents]\Visual Studio 2017. If you run into trouble, it might help to watch [this video](#).

Older versions of Visual Studio will not work because they don't allow you to use version the version of .NET Framework required by NX.

Unfortunately, the Visual Studio Express download is much larger than it was when it was first released — it has grown from around 80 MB to over 1.1 GB. If you don't have the patience or disk space to handle a package this large, you can try [the SharpDevelop IDE](#), instead. It's only around 15MB, and provides everything you need. The instructions you read in this document won't match SharpDevelop exactly, but it should be fairly easy to adapt.

In the examples in this chapter, we'll provide step-by-step instructions for writing the code, just as we did in chapter 2, so it should be easy to follow. But if you'd like to get some additional information about the Visual Basic language or Visual Studio, then one good place to start is [this series of videos](#). There is a huge amount of other tutorial material available on the internet, and you might find other sources preferable, especially if your native language is not English.

## ■ Installing NX Open Templates

After installing Visual Studio, you should install two custom templates that we will be using as convenient starting points when developing NX Open programs. You will find two zip files in `[...NX]\UGOPEN\NXOpenExamples\VB\Templates`. Again, remember that `[...NX]` is just shorthand for the location where NX is installed, which is typically somewhere like `C:\Program Files\Siemens\NX 12`. The names of the files are `NXOpenApplication.zip` and `NXOpenWinFormApplication.zip`. Copy these two zip files into the folder `[My Documents]\[Visual Studio]\Templates\ProjectTemplates\Visual Basic`.

For added clarity, here are the same instructions in pictorial form showing the Visual Studio 2013 as the `[Visual Studio]`:

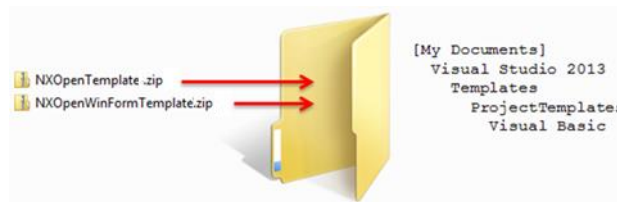

Unfortunately, experience has shown that people often do this step wrong, so we're going to yell at you...

**NOTE:** please **do not** extract the contents from the zip files; just **copy the zip files themselves**.

**NOTE:** please note that the **NX Open Templates** are different than the **NX Wizards**. The NX Templates will work with both Visual Studio and Visual Studio Express. While the **NXOpen Wizards** will only work with the **Visual Studio**. For more information about the NX Open Wizards please see the Programming Tools section of the Technical Documents.

## ■ Licensing Issues Again

You will need an NX Open .Net Author license to run NX Open dlls built from Visual Studio. If you do not have an NX Open .Net Author license, you can edit NX Open Visual Basic journals in Visual Studio and replay the journal in NX as long as the journal is arranged to be in one file.

## ■ Example 1: Hello World Again

Our first exercise is to create a "Hello World" application again. Sorry, we know it's boring, but it's a tradition. After you get Visual Studio Express installed and running, choose New Project from the File menu. A "project" is the name Visual Studio uses for a collection of related files. You will see a list of available project templates

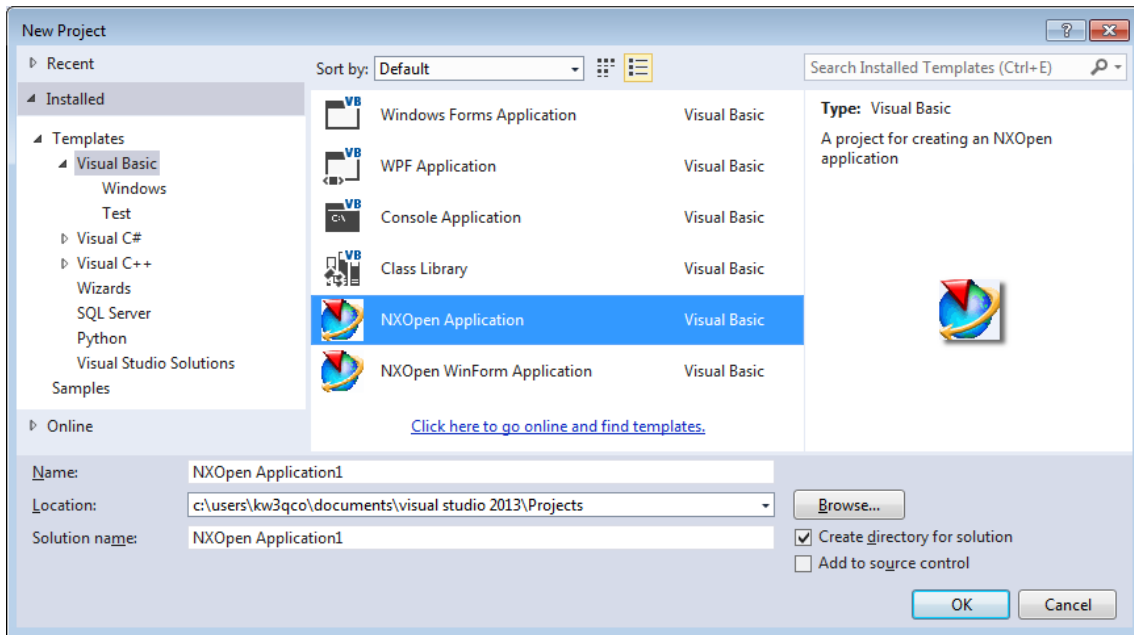

Choose the “NX Open Application” template. This is a special custom template designed to serve as a convenient starting point for certain kinds of NX Open applications. Also, give your project a suitable name — something like “HelloApp” would be good.

The NX Open Application template gives you a framework for a simple NX Open application, as shown here:

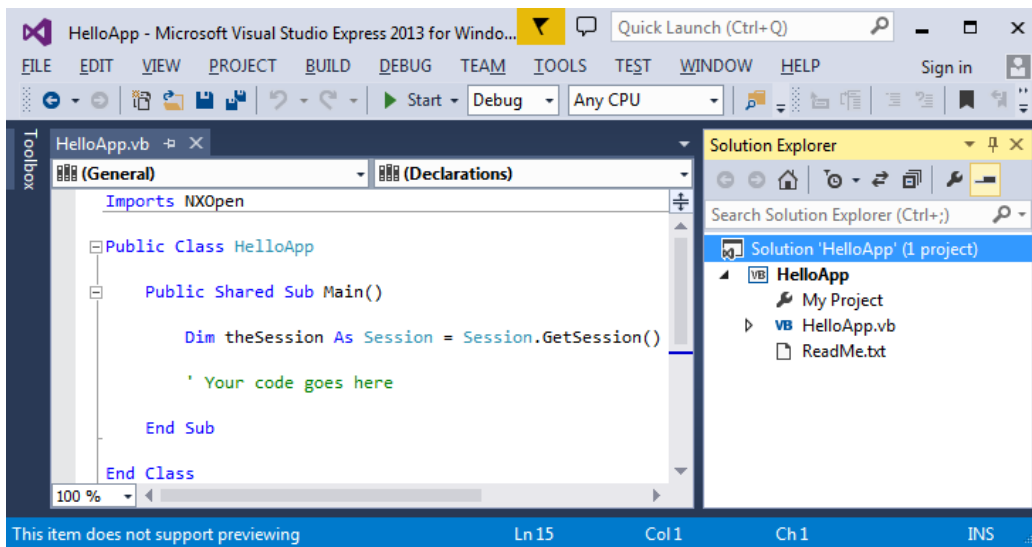

In the left-hand pane, you can see some familiar VB code, which the template has placed in a file called **MyProgram.vb** for you. We need to make a couple of changes to this code: add **Option Explicit Off** at the top, and add a line that outputs some message to the Information window, as shown here:

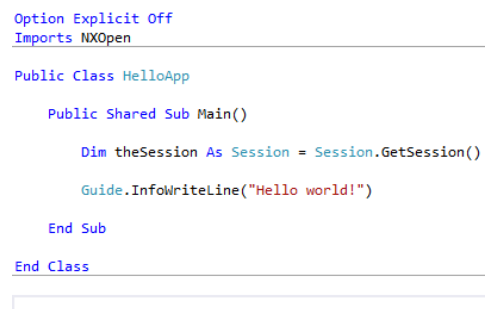
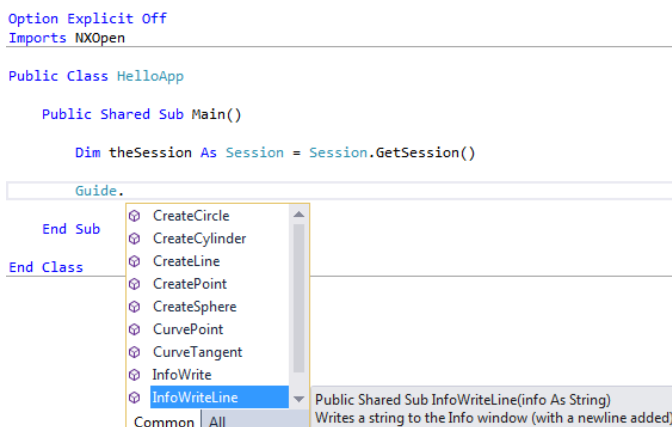

You should type the new code, rather than just copying and pasting it, because some interesting things happen as you type (as you saw in the tutorial videos, if you watched them). In fact, it's interesting to type the entire 7 lines of code. You will find that you actually only have to type 5 lines — Visual Studio will type the other two for you. Generally, Visual Studio helps you by suggesting alternatives, completing words, correcting mistakes, showing you documentation, and so on. To accept the highlighted alternative, you can either press Tab, or type another character, like a period or a parenthesis. All of this is called “Intellisense” by Microsoft’s marketeers. Despite its dubious name, you’ll find it very helpful as your programming activities progress. Also, notice that Visual Studio automatically makes comments green, literal text red, and language keywords blue, to help you distinguish them.

Next, you are ready to compile (or “build”) your code into an executable application. To do this, go to the Build menu and choose Build HelloApp, or press Ctrl+Shift+B, which will send your code to the VB compiler. The compiler will translate your code into an executable form that your computer can run, and will store this in a file called **HelloApp.dll**. The extension “dll” stands for “Dynamic Link Library”, which is a type of file that holds executable code. You should get the good news about the build succeeding down at the bottom left:

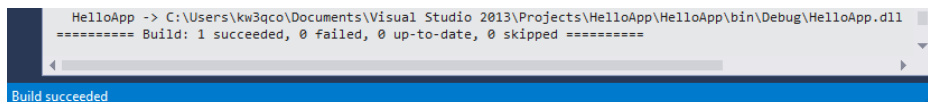

On the other hand, if you’re unlucky, you might get some error messages like these:

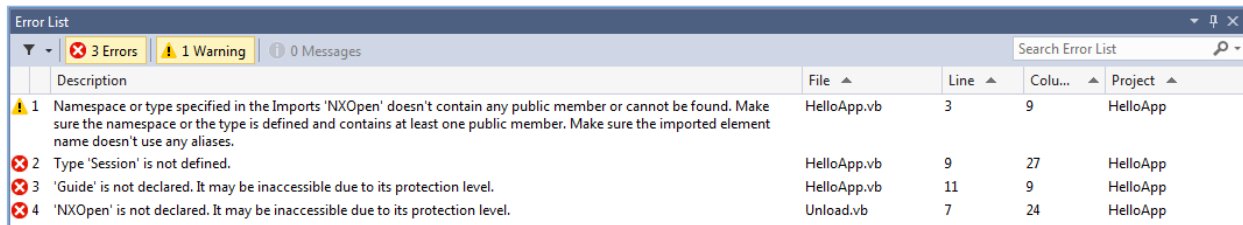

It’s not very likely that this problem will occur, so we don’t want to interrupt the flow by discussing all the details here. The possible causes and corrective actions are described in [chapter 17](#).

At some point, you should save your project by choosing Save All from the File menu. Visual Studio will offer to save in your Projects folder, whose path is typically something like **[My Documents]\[Visual Studio]\Projects**.

Now, we are ready to run our new application. From within NX, choose File → Execute → NX Open (or press Ctrl+U). Your version of the NX user interface might not have the Execute option installed in the File menu, but the Ctrl+U shortcut will work anyway.

A dialog will appear that allows you to find your executable. As mentioned earlier, it will be called **HelloApp.dll**, and it will be located in **[My Documents]\[Visual Studio]\Projects\HelloApp\HelloApp\bin\Debug** along with two other files that you don’t need to worry about.

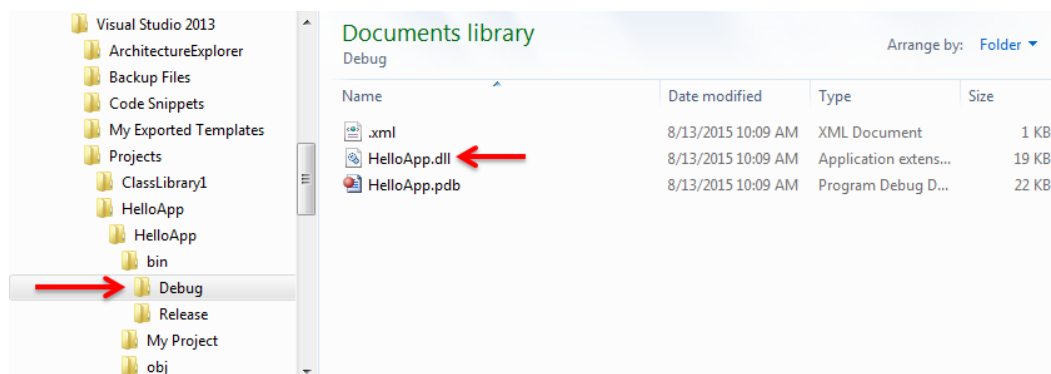

To see HelloApp.dll, make sure you set the “Files of type” filter in the NX dialog to “Dynamic Loadable Libraries (\*.dll)”. Double-click on HelloApp.dll, and a friendly greeting should appear in your NX Listing window. If you can’t find your application, try looking in the **bin\Release** folder, rather than the **bin\Debug** folder. If you still can’t find it, it’s probably because you forgot to save it, or you didn’t set the file type filter correctly.

There’s a useful trick that allows you to locate your executable quickly. When you build the application, some text like this will appear in the “Output” pane at the bottom of your Visual Studio window:

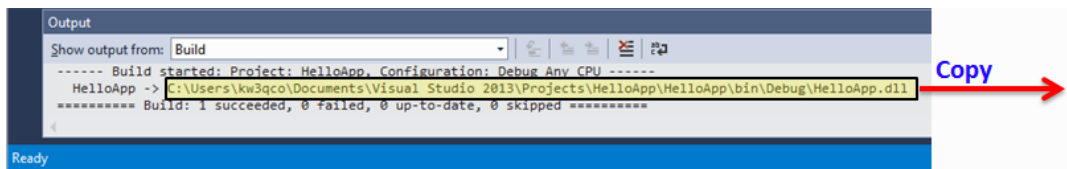

If the output pane is not visible, press **Ctrl+Alt+O** to display it (that's the letter O, not the number zero). You can then just copy the pathname of the newly-created application (highlighted in yellow above) and paste it into the "Execute" dialog within NX. This technique is highly recommended — it avoids all the hunting around folders that we described above, and it ensures that you are running the code that you just built. You only have to do this once per NX session, because NX will remember the location for you.

## ■ Example 2: Declaring Variables

In this example, we will do some vector calculations to compute the radius of a circle through three points. We will focus on the topic of "declaring" the variables we use, to see how this affects things.

If your previous project is still open in Visual Studio, close it by choosing **File → Close Project**. Then choose **New Project** from the File menu, use the **NX Open Application** template to create a project, and give it the name **ThreePointRadius**, or something like that.

As before, add the line **Option Explicit Off** at the top of the file. For reasons explained below, this is the last time we're going to do this in our examples. Then, replace the line "**Your code goes here**" with the following:

```
Dim sel = NXOpen.UI.GetUI.SelectionManager
Dim myView As View
Dim p1, p2, p3 As Point3d
sel.SelectScreenPosition("Specify first point", myView, p1) ' Get first point from user
sel.SelectScreenPosition("Specify second point", myView, p2) ' Get second point
sel.SelectScreenPosition("Specify third point", myView, p3) ' Get third point

u As New Vector3d(p2.X - p1.X, p2.Y - p1.Y, p2.Z - p1.Z) ' Vector3d from p1 to p2
v As New Vector3d(p3.X - p1.X, p3.Y - p1.Y, p3.Z - p1.Z) ' Vector3d from p1 to p3
uu = u.X * u.X + u.Y * u.Y + u.Z * u.Z ' Dot product of vectors
uv = u.X * v.X + u.Y * v.Y + u.Z * v.Z
vv = v.X * v.X + v.Y * v.Y + v.Z * v.Z
det = uu * vv - uv * uv ' Determinant for solving linear equations
alpha = (uu * vv - uv * vv) / (2 * det) ' Bad code !! Should check that det is not zero
beta = (uu * vv - uv * uv) / (2 * det)
rx = alpha * u.X + beta * v.X ' Radius vector components
ry = alpha * u.Y + beta * v.Y
rz = alpha * u.Z + beta * v.Z
radius = Math.Sqrt(rx*rx + ry*ry + rz*rz) ' Radius is length (norm) of this vector
Guide.InfoWriteLine(radius) ' Output to Info window
```

Again, you can gain some experience with Intellisense if you type this code, rather than copying and pasting it. The only thing that's new here is the function **SelectScreenPosition**, which allows you to get a screen point location from the user.

As before, you can save this project, build it, and run it from within NX using **File → Execute → NX Open** (or **Ctrl+U**).

Now let's see what happens if you make a typing error. Change the line that calculates "det" to read

```
det = uu * vv - uv * u
```

In other words, change the last term from "**uv**" to "**u**". Then build the project and try running it again. It will still build successfully, but when you run it from within NX, you'll get an error message like this:

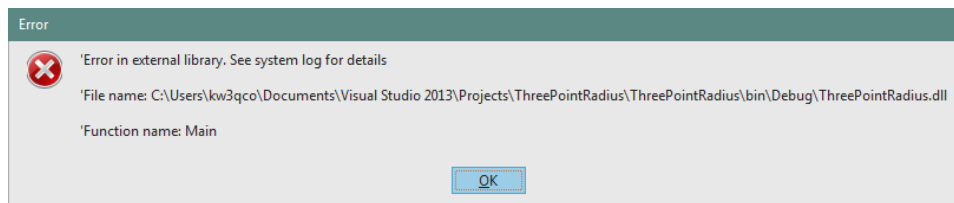

If you choose Help → Log File from within NX, and hunt around the NX System Log, you will find some more error messages about 50 lines from the bottom, most notably these ones

```
Caught exception while running: Main
System.InvalidCastException: Operator '*' is not defined for type 'Double' and type 'Vector3d'.
at Microsoft.VisualBasic.CompilerServices.Operators.InvokeObjectUserDefinedOperator ... blah blah blah
at Microsoft.VisualBasic.CompilerServices.Operators.MultiplyObject(Object Left, Object Right)
at ThreePointRadius.ThreePointRadius.Main() in C:\Users\ ... \ThreePointRadius.vb:line 21
```

Obviously it would be much better to discover errors like this earlier, as you’re writing the code, rather than when you run the application. And, in fact, you can, if you change the way you write the code, and give the compiler a little more information. The key is a process called “declaring” variables, which lets us tell the compiler about their types.

To see how this works, change your code to read:

```
Dim u As New Vector3d(p2.X - p1.X, p2.Y - p1.Y, p2.Z - p1.Z)
Dim v As New Vector3d(p3.X - p1.X, p3.Y - p1.Y, p3.Z - p1.Z)
Dim uu As Double = u.X * u.X + u.Y * u.Y + u.Z * u.Z
Dim uv As Double = u.X * v.X + u.Y * v.Y + u.Z * v.Z
Dim vv As Double = v.X * v.X + v.Y * v.Y + v.Z * v.Z
```

The phrase “Dim u As New Vector3d” tells the compiler that the variable **u** is supposed to hold a Vector3d object, and so on. So, the compiler now knows that **u** and **v** are vectors, and **uu**, **uv**, and **vv** are numbers (doubles). So the expression **uv\*u** is trying to multiply a vector by a number, which is not a legal operation in this context. So we get a “squiggly underline” error indicator, and we know immediately that we have made a mistake. And, if you hover your mouse over the mistake, a message will appear telling you what you did wrong:

```
Dim u As New Vector3d(p2.X - p1.X, p2.Y - p1.Y, p2.Z - p1.Z)
Dim v As New Vector3d(p3.X - p1.X, p3.Y - p1.Y, p3.Z - p1.Z)
Dim uu As Double = u.X * u.X + u.Y * u.Y + u.Z * u.Z
Dim uv As Double = u.X * v.X + u.Y * v.Y + u.Z * v.Z
Dim vv As Double = v.X * v.X + v.Y * v.Y + v.Z * v.Z
det = uu * vv - uv * u
```

Up until now, our applications have been very simple, so there was not much justification for the extra effort of declaring variables. But, as you start to write more complex applications, you will definitely want the compiler to help you find your mistakes. And it can do this very effectively if you declare your variables. Actually, many programming languages require you to declare all variables. Visual Basic is an exception — if you use the “Option Explicit Off” directive at the start of your code, as we have been doing, then you don’t have to. But declaring variables is a good thing, so we’re going to do it from now on. For further discussion of declaring variables (and avoiding or shortening declarations), please see [chapter 4](#).

### ■ Example 3: WinForms Again

One of the nice things about Visual Studio is the set of tools it provides for designing user interface dialogs using Windows Forms (WinForms, for short). We’re going to recreate the “Create Random Spheres” dialog from the previous chapter, but it will be much easier this time, using Visual Studio, and the dialog will look nicer.

Run Visual Studio Express, and choose New Project from the File menu. Instead of choosing the NX Open Application template, chose the NX Open WinForm Application template this time. Call your new project NXOpenWinFormApp.

Your new project will look something like this:

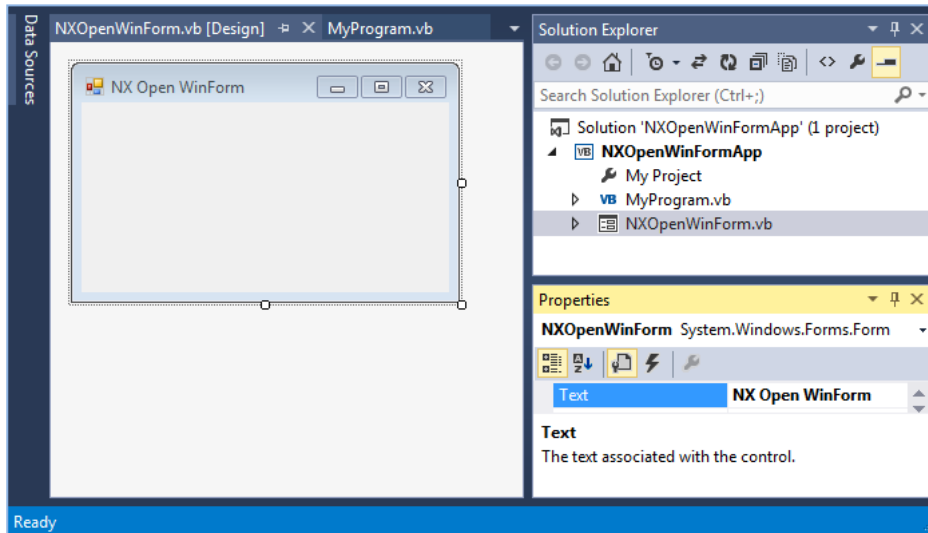

You may need to double-click on `NXOpenWinForm.vb` to see the new Windows form in the left-hand pane. In the lower right-hand pane, all the “properties” of the new WinForm are listed, along with their values. As you can see, the form has a property called “Text”, and this property currently has the value “NX Open WinForm”. This property actually represents the text in the title bar of the dialog. Edit this text to read “Create Sphere”. When you do this, you will see that the dialog title bar changes, too.

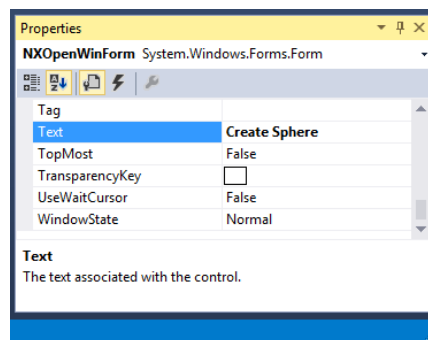

Next, as before, we’re going to add a button to our form. On the left-hand side of the Visual Studio window, you should see a Toolbox containing various types of user interface objects. If you don’t see the Toolbox, choose it from the View menu, or press `Ctrl+Alt+X`.

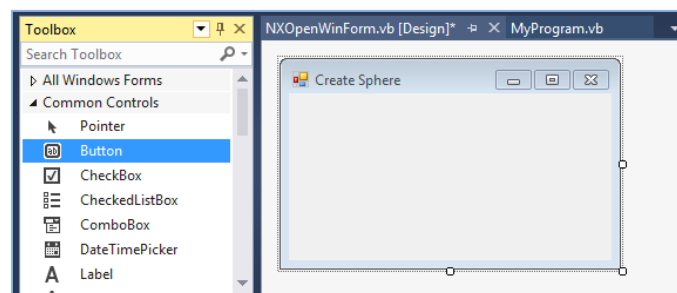

Click on the “Button” object. The cursor will change to a small “+” sign, and you can then use it to graphically draw a button on the form. Initially, the button will be labeled with the text “Button1”, but you can change this to “Click me” or whatever you want by editing the text property of the button, just as we edited the text property of the form.

You can edit other properties of the button, too, like the font used and the background color. Your result might be something like this:

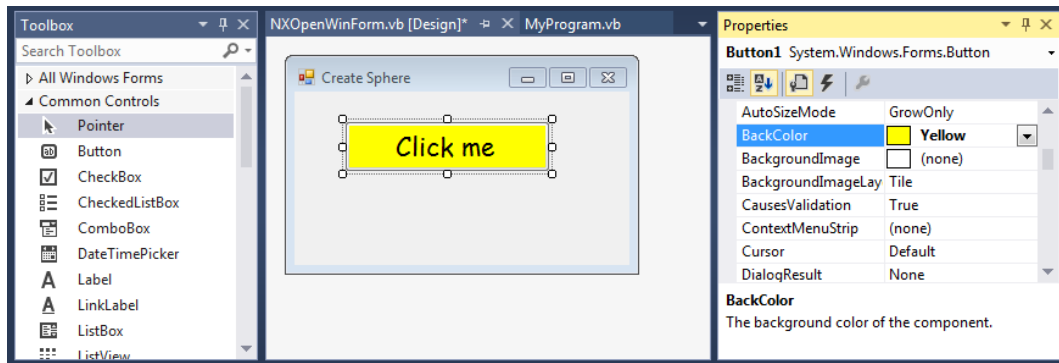

Also, you can adjust the sizes of the button and the form by dragging on their handles:

Next, let's make the button do something useful. Double-click the button, and a code window will appear, like this:

```
Imports NXOpen

Public Class NXOpenWinForm

    Private Sub Button1_Click(sender As System.Object, e As System.EventArgs) Handles Button1.Click

    End Sub

End Class
```

The function you see is an event handler for the button's "click" event. Currently, it doesn't do anything, but you can edit it as shown below to make the click event create a sphere, or whatever else you want it to do.

```
Private Sub Button1_Click(sender As System.Object, e As System.EventArgs) Handles Button1.Click
    Guide.InfoWriteLine("Creating a sphere")
    Guide.CreateSphere(0, 0, 0, 10)
End Sub
```

When we created this dialog manually, in the previous chapter, you may recall that we wrote code like this:

```
myForm.Text = "Create Random Spheres"
myButton = New Button 'Create a button
myButton.BackColor = Color.Yellow 'Color it yellow
myButton.Text = "Click me" 'Put some text on it
myForm.Controls.Add(myButton) 'Add it to our form
```

This same sort of code exists in our current project, too, but it was written for us by Visual Studio, and it's somewhat hidden, because you're not supposed to edit it. To see this code, click on the Show All Files button at the top of the Solution Explorer window, and then double-click on the file named `NXOpenWinForm.Designer.vb`.

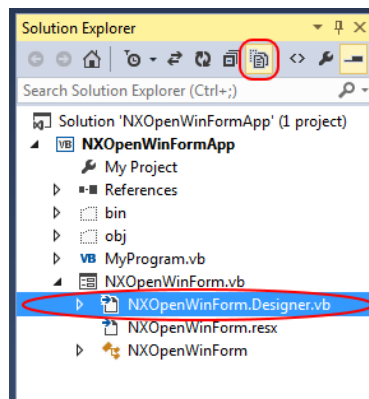

To display our dialog, we have a couple of lines of code in Sub Main in the file `MyProgram.vb`:



```
Public Shared Sub Main()
    Dim form As New NXOpenWinForm()
    form.ShowDialog()
End Sub
```

As before, we're using `form.ShowDialog` to display the dialog, so it will be "modal", which means that we can't do anything else until we close the form. There is also `myForm.Show`, which creates a non-modal form, but to use this, you have to change the `GetUnloadOption` function in the file `Unload.vb`. Specifically, you have to modify this function to return `NXOpen.UnloadOption.AtTermination` instead of `NXOpen.UnloadOption.Immediately`. If you fail to do this, your dialog will disappear a second or two after it's displayed, so you'll probably never see it.

Build the project, and run it from within NX, as usual. When your dialog appears, you can click on your button to create spheres. When you get bored with this, click the "X" to close your dialog.

If you want to learn more about creation of WinForm-based user interfaces, there are many books and on-line tutorials available on the subject, including [this tutorial](#).

## ■ Example 4: Hello World Yet Again (the Hard Way)

Sorry, but we're going to create a "Hello World" application yet again. This time, we're going to do it without getting any assistance from the NX Open template we used last time. This will help you understand what is happening "behind the scenes" so that you will know what to do if you run into problems later. If you're not interested in this, you can skip to the next example.

Run Visual Studio Express, and choose New Project from the File menu. You will see the available set of project templates. But, this time, instead of choosing the NX Open Application template, choose the Class Library one:

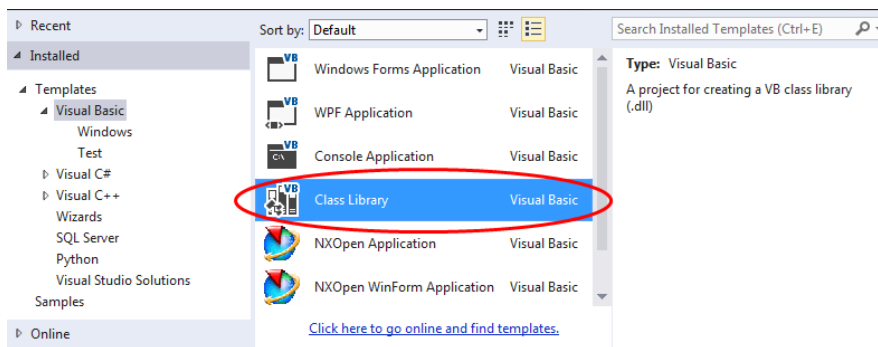

You might be thinking that you could use the "Console Application" template, instead. Unfortunately, there are some technical reasons why this will not work — on some systems, it will lead to a mysterious "failed to load image" error when you try to run your application from within NX. Please see [chapter 17](#) for more details.

This Class Library template gives you a framework for a Visual Basic class definition. You will see a file called `Class1.vb` that contains a couple of lines of code. Delete this code and paste (or type) the contents of `NXOpenSample.vb` in its place. Delete the first line (the one that says `Option Explicit Off`). Also, delete the line that says `Your code goes here`, and replace it by `Guide.InfoWriteLine("Hello world!")`, as we have done several times before. You should end up with something that looks like this:

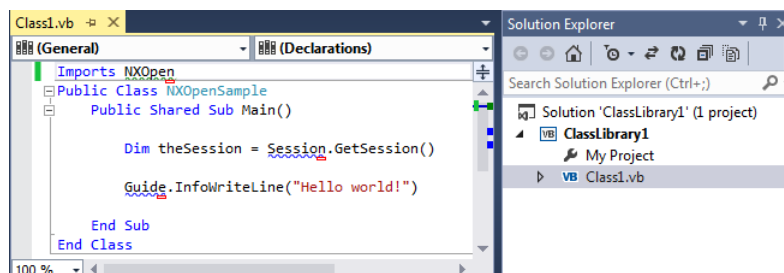

As you're typing, you might notice that the usual "Intellisense" doesn't work. This is the first indication that something is wrong. Also, you will see several squiggly underlines, and some error and warning messages in the list at the bottom of the window:

Error List				
2 Errors 1 Warning 0 Messages				
Search Error List				
Description	File	Line	Colu...	Project
1 Namespace or type specified in the Imports 'NXOpen' doesn't contain any public member or cannot be found. Make sure the namespace or the type is defined and contains at least one public member. Make sure the imported element name doesn't use any aliases.	Class1.vb	2	9	ClassLibrary1
2 'Session' is not declared. It may be inaccessible due to its protection level.	Class1.vb	6	26	ClassLibrary1
3 'Guide' is not declared. It may be inaccessible due to its protection level.	Class1.vb	8	9	ClassLibrary1

Most of the problems arise because our code is using the `NXOpen` libraries, and these are not connected in any way to our current project. So the compiler doesn't know anything about NX Open, or the `NXOpen.Guide.InfoWriteLine` function. To fix this, we need to add a "reference" to the `NXOpen` libraries. From the Project menu, choose Add Reference. In the dialog that appears, click on the Browse tab, and navigate to the folder `[...NX]\NXBIN\managed`:

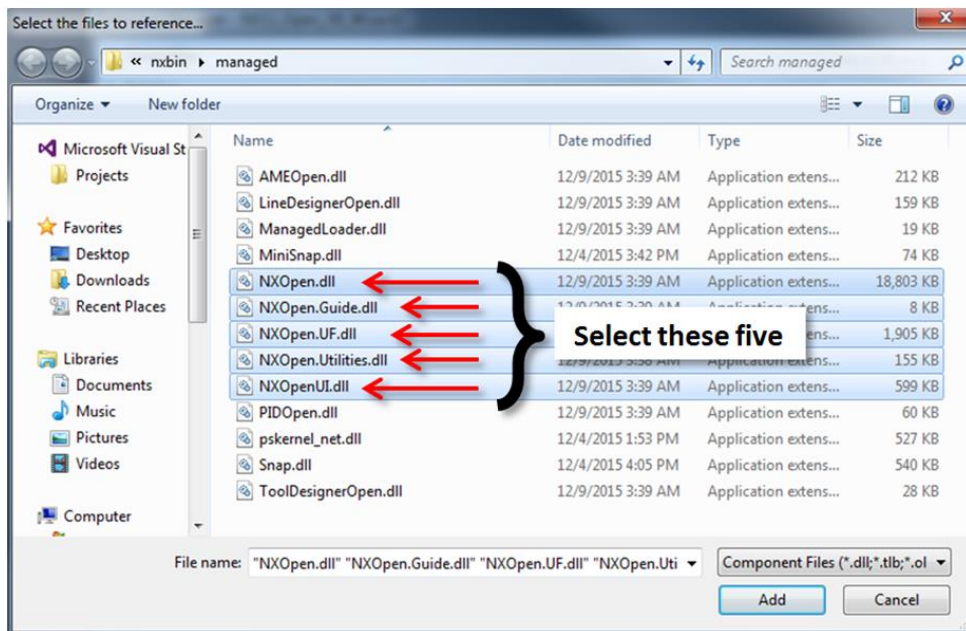

You will see a number of DLLs. We only need the NX Open DLLs in this example. Select five DLLs, as shown above, and click OK. Your project now has references to the NX Open libraries, and this should remove the complaints about them "containing no public members". Now you can build and run the application, as usual.

The NX Open Application template that we used previously already includes the references to the NX Open libraries, so you didn't have to add them manually. But, it's useful to know how to do this when you need to. For example, if you want to use some .NET Framework functions in any journals you write, you may have to add references to the assemblies where they reside. If you forget to do this, you will get "type not defined" errors, like the ones we saw above. Please see [chapter 17](#) for more information about problems with references.

A project based on the Class Library template has another deficiency — it doesn't include a `GetUnloadOption` function. This means that NX won't know how to "unload" your code after it has finished executing — in some sense, NX "holds onto" your code, and won't let it go. So, if you try to change your code and rebuild the project, you'll get an error message telling you that you "can't access the file because it is being used by another process". The other process is NX, and you'll have to terminate NX to get it to release its hold on your DLL so that you can rebuild it. The NX Open Application Template provides a `GetUnloadOption` function for you, so you won't have these sorts of problems. Writing your own `GetUnloadOption` function is fairly simple. The code is as follows:

```
Public Shared Function GetUnloadOption(ByVal dummy As String) As Integer
    Return CType(NXOpen.Session.LibraryUnloadOption.Immediately, Integer)
End Function
```

It's convenient to place this code in the same class or module as your "Main" function — in our case, this means inside the `NXOpenSample` class that we created. So, you just need to paste this code immediately before the line that says "End Class". Please look up `GetUnloadOption` in the NX Open Programmer's Guide for more information about unloading code.

## ■ Example 5: Editing a Recorded Journal

Our next example covers how to edit a recorded journal to create a reusable application. We will use a simple workflow to show the general procedure for editing the recorded journal to remove the specific recorded selections and replace them with selection operations that will work on generic parts. We have an example file you can use in `ChangeLayerOfBody.vb` where we recorded a journal that changes the layer of a selected body to layer 45. This journal is listed below:

```
' NX 12.0.0.8
Imports System
Imports NXOpen

Module NXJournal
  Sub Main(ByVal args() As String)

    Dim theSession As NXOpen.Session = NXOpen.Session.GetSession()
    Dim workPart As NXOpen.Part = theSession.Parts.Work

    Dim displayPart As NXOpen.Part = theSession.Parts.Display

    ' -----
    '   Menu: Format->Move to Layer...
    ' -----

    Dim markId1 As NXOpen.Session.UndoMarkId
    markId1 = theSession.SetUndoMark(NXOpen.Session.MarkVisibility.Visible, "Move Layer")

    Dim objectArray1(0) As NXOpen.DisplayableObject
    Dim body1 As NXOpen.Body = CType(workPart.Bodies.FindObject("CYLINDER(2)"), NXOpen.Body)

    objectArray1(0) = body1
    workPart.Layers.MoveDisplayableObjects(45, objectArray1)

    ' -----
    '   Menu: Tools->Journal->Stop Recording
    ' -----

  End Sub
End Module
```

After the lines creating an undo mark for the operation is a line that specifies the body that you want to move to layer 45. This line:

```
Dim body1 As NXOpen.Body = CType(workPart.Bodies.FindObject("CYLINDER(2)"), NXOpen.Body)
```

looks for the body named "CYLINDER(2)". We will replace this line by a selection. In the listing below we have edited our journal to ask the user to select a body to edit:

```

' NX 12.0.0.8

Imports System
Imports NXOpen
Imports NXOpen.Selection ' Added to make selection code simpler

Module NXJournal
  Sub Main(ByVal args() As String)

    Dim theSession As NXOpen.Session = NXOpen.Session.GetSession()
    ' Get UI object
    Dim theUI As NXOpen.UI = NXOpen.UI.GetUI()
    Dim sel As NXOpen.Selection = theUI.SelectionManager
    Dim workPart As NXOpen.Part = theSession.Parts.Work
    Dim displayPart As NXOpen.Part = theSession.Parts.Display

    ' -----
    ' Menu: Format->Move to Layer...
    ' -----

    Dim markId1 As NXOpen.Session.UndoMarkId
    markId1 = theSession.SetUndoMark(NXOpen.Session.MarkVisibility.Visible, "Move Layer")

    Dim objectArray1(0) As NXOpen.DisplayableObject
    'Dim body1 As NXOpen.Body = CType(workPart.Bodies.FindObject("CYLINDER(2)"), NXOpen.Body)
    ' Ask user to select object
    Dim selObj As TaggedObject
    Dim cursor As Point3d
    Dim resp As Response = sel.SelectTaggedObject("Select Object", "Select Object",
        SelectionScope.UseDefault, False, False, selObj, cursor)
    If resp <> Response.Back And resp <> Response.Cancel Then

        objectArray1(0) = body1
        objectArray1(0) = CType(selObj, DisplayableObject)
        workPart.Layers.MoveDisplayableObjects(45, objectArray1)

    End If

    displayModification1.Dispose()
    ' -----
    ' Menu: Tools->Journal->Stop Recording
    ' -----

  End Sub
End Module

```

This modified journal uses a selection dialog to ask the user to pick a body to move to layer 45. We can make this a little neater by moving the selection code into a separate function and calling it from our main program. The following listing shows a journal with the selection code placed in a Function called [SelectBody](#). This function will return the selected body if the user selects a body or [Nothing](#) if the user presses Back or Cancel.

```

' NX 12.0.0.8

Imports System
Imports NXOpen
Imports NXOpen.Selection ' Added to make selection code simpler

Module NXJournal
    Sub Main(ByVal args() As String)

        Dim theSession As NXOpen.Session = NXOpen.Session.GetSession()
        Dim workPart As NXOpen.Part = theSession.Parts.Work
        Dim displayPart As NXOpen.Part = theSession.Parts.Display

        ' -----
        ' Menu: Edit->Object Display...
        ' -----

        Dim markId1 As NXOpen.Session.UndoMarkId
        markId1 = theSession.SetUndoMark(NXOpen.Session.MarkVisibility.Visible, "Move Layer")

        Dim objectArray1(0) As NXOpen.DisplayableObject
        'Dim body1 As NXOpen.Body = CType(workPart.Bodies.FindObject("CYLINDER(2)"), NXOpen.Body)
        ' Ask user to select object
        Dim body1 As Body = SelectBody()
        If body1 IsNot Nothing Then
            objectArray1(0) = body1
            workPart.Layers.MoveDisplayableObjects(45, objectArray1)
        End If
        displayModification1.Dispose()
        ' -----
        ' Menu: Tools->Journal->Stop Recording
        ' -----

    End Sub

    ' Function to ask user to select a body
    Function SelectBody() As Body
        Dim body1 As Body = Nothing
        ' Get UI object
        Dim theUI As NXOpen.UI = NXOpen.UI.GetUI()
        Dim sel As NXOpen.Selection = theUI.SelectionManager
        Dim objects1(0) As NXOpen.DisplayableObject
        Dim selObj As TaggedObject
        Dim cursor As Point3d
        Dim message As String = "Select Body"
        Dim title As String = "Selection"
        Dim resp As Response = sel.SelectTaggedObject(message, title, SelectionScope.UseDefault,
            False, False, selObj, cursor)
        If resp <> Response.Back And resp <> Response.Cancel Then
            If TypeOf selObj Is Body Then
                body1 = CType(selObj, Body)
            End If
        End If
        Return body1
    End Function
End Module

```

The SelectBody function checks if the selected object is a Body. If it is not, then the function returns **Nothing** for the selected body. Other selection functions allow you to filter the selected objects to specific types. If you are interested in filtering, you can read ahead in chapter 15, which covers the NX Open Selection API in more detail.

## ■ Debugging in Visual Studio

The full version of Visual Studio (**but not the Express edition**) provides an excellent debugger that lets you step through your code one line at a time, watching what's happening as it executes. In particular, you can set "breakpoints" that pause the execution of your code, allowing you to examine variable values. This is a very good way to find problems, obviously. The techniques used with SNAP and NX Open programs are a little unusual because you are debugging code called by a "Main" function that you don't have access to (because it's inside NX). This means that using the normal "Start Debugging" command within Visual Studio is not appropriate. There are two alternative approaches, as outlined below, but neither of these is available in Visual Studio Express editions.

### Using Debugger.Launch

First, you write `System.Diagnostics.Debugger.Launch` somewhere near the beginning of your code, and then you run your application in the normal way using File → Execute → NX Open. When execution reaches the `Debugger.Launch` call, the Just-In-Time Debugger dialog will appear, asking you which debugger you want to use:

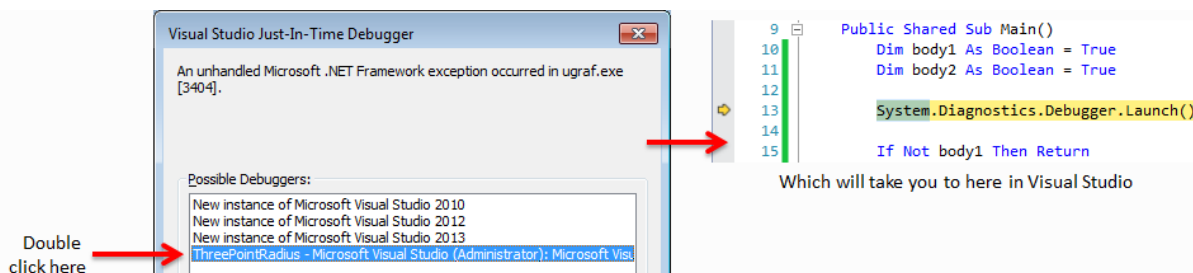

Double-click on the debugger for your current project, as shown in the picture above, and you will be taken back to Visual Studio with your code "paused" at the `Debugger.Launch` line, ready to begin stepping through it.

### Using Attach To Process

Within Visual Studio, choose Tools → Attach to Process (or press Ctrl+Alt+P), and double-click on the NX process (ugraf.exe) in the list of available processes. Again, run your application using File → Execute → NX Open, and you will arrive back in Visual Studio with your code "paused" at the first breakpoint.

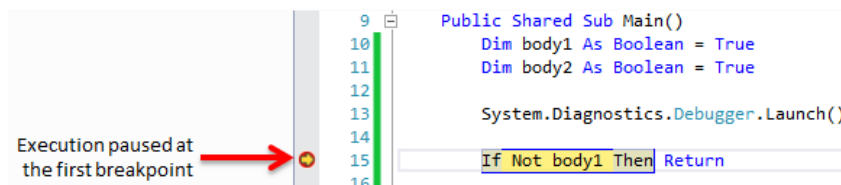

Regardless of which of the two approaches you used, you are now ready to step through your code. The available options are shown in the Debug menu or on the Debug Toolbar within Visual Studio. For information on how to use the debugger facilities, please consult one of the many tutorials available on the internet.

---

# Chapter 4: The Visual Basic Language

---

One of the strengths of NX Open is that it is based on standard mainstream programming languages. This means there are many excellent tools you can use (like Visual Studio), and there's lots of tutorial and help material available. This chapter provides an introduction to the Visual Basic language (which we have been using for all of our examples). There are many places where you can learn more about Visual Basic (like [this series of videos](#), for example), so our description here will be very brief.

When looking for books and on-line tutorials, you should be aware that the Visual Basic language has evolved significantly over the years. What we are using here is Visual Basic for .NET. Older versions (like Visual Basic 6, for example), are quite different. So, when you start reading, make sure you are using fairly modern materials. If you really want the complete story, you can read the Microsoft documentation on [this web page](#).

If you prefer to use the C# language, instead of Visual Basic, then [these videos](#) should be helpful.

## ■ The Development Process

The basic process of creating a program in Visual Basic (or any other language) is shown below

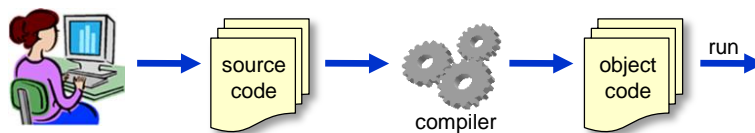

The process is quite simple, but unfortunately it typically involves quite a lot of programmer jargon. The Visual Basic statements you write are known as “source code”. This code is typically contained in one or more text files with the extension “.VB”. Your source code is then sent to a compiler, which converts it into “object code” that your computer can actually understand and run. The object code is sometimes referred to as an “executable” or a “library”, or an “assembly”, and is held in a file with the extension “.EXE” or “.DLL”.

## ■ Structure of a Visual Basic Program

A Visual Basic program has standard building blocks, typically present in the following sequence:

- **Option** statements
- **Imports** statements
- The **Main** procedure
- **Class** and **Module** elements

### Option Statements

**Option** statements establish ground rules for subsequent code. **Option Explicit On** ensures that all variables are declared, which may make debugging easier. **Option Strict On** applies more strict rules to variable type conversions, which helps prevent problems that can occur when you transfer information between variables of different types. **Option Infer On** asks the compiler to try to guess the types of your variables, which reduces the need for declarations, as explained a little later, in the section entitled [Omitting Declarations](#).

If you place **Option** statements in your source code, they must be placed at the beginning of a source file, and they apply only to the source file in which they appear. Another approach is to specify compilation options in the properties of a Visual Studio project, in which case they apply to the entire project. This is often more convenient.

### Imports Statements and Namespaces

Placing an **Imports** statement at the beginning of a source file allows you to use abbreviated names within that file (rather than longer “fully qualified” ones), which reduces your typing effort. For example, suppose you will frequently be using the `System.Console.WriteLine` function to output text. If you write `Imports System.Console` at the beginning of your source file, then you can refer to this function as simply `WriteLine` whenever you need it.

In Visual Basic, the thing that appears in an `Imports` statement can be either a class or a namespace. Classes are explained later in this chapter. Namespaces help you to organize large quantities of code into related subgroups, and to distinguish different uses of the same name. Suppose you had a large application that performed operations on both fish and musical instruments. This probably isn't very likely, but it provides a convenient illustration. You might invent two namespaces called `Instruments` and `Fish` to hold your code. You could use the name `Bass` within both of these namespaces, because `Instruments.Bass` and `Fish.Bass` would be two different names. If you wrote `Imports Instruments` at the top of a code file, you could use the name `Bass` instead of `Instruments.Bass`. If you wrote both `Imports Instruments` and `Imports Fish`, then you would create a problem, of course, because then the name `Bass` would be ambiguous.

## The Main Procedure

The `Main` procedure is the “starting point” for your application — the first procedure that is accessed when you run your code. `Main` is where you would put the code that needs to be accessed first.

## Classes, Modules, and Files

Each line of executable code must belong to some class or module. Classes are explained near the end of this chapter. For now, you can consider a class to be a related collection of code and data fields, often representing some generic type of object. A module is really a special simplified type of class. Modules are not as flexible as classes, and they are not used as much in real-world applications, but we use them in this document because they provide a convenient way to temporarily manage smallish snippets of code. As you may recall, the NX Journaling function always produces code that is packaged into a Module. Many people advocate placing each class in its own source file, and giving this source file the same name as the class, but, you can place several classes in a single file, if you want to. Conversely, you do not have to put an entire class within a single file — by using the “partial class” capability, you can split a class definition into several files, which is often useful.

## ■ An Example Program

The listing below shows a simple program containing most of the elements mentioned above.

```
Option Infer On
Imports System, NXOpen

Module MyProgram

    Sub Main()
        Dim radius As Double = 3.75
        Dim area As Double
        area = CircleArea(radius)
        Dim message As String = "Area is: "
        Guide.InfoWriteLine(message & area)
    End Sub

    ' Function to calculate the area of a circle
    Function CircleArea(r As Double) As Double
        Dim pi As Double = System.Math.PI
        Dim area As Double = pi * r * r
        Return area
    End Function

End Module
```

The program starts with an `Option` statement and an `Imports` statement. Then there is a single module called “MyProgram” that holds all the executable code. Inside this module there is a “`Main`” procedure, as always, and then another function called `CircleArea`.



The following table gives more details:

Lines of code	Explanation
<code>Option Infer On</code>	Tells the compiler that it should try to guess the types of variables if you don't declare them explicitly
<code>Imports NXOpen</code>	Allows you to refer to functions in the NXOpen namespace using short names
<code>Dim radius As Double = 3.75</code>	Declares a variable of type <code>Double</code> , gives it the name <code>radius</code> , and stores the value 3.75 in it.
<code>Dim area As Double</code>	Declares another variable of type <code>Double</code> , and names it <code>area</code>
<code>area = CircleArea(radius)</code>	Calls a function named <code>CircleArea</code> , which is defined below. The variable <code>radius</code> is used as the input to this function, and the output returned from the function is written into the variable named <code>area</code> .
<code>Dim message As String = "Area is: "</code>	Declares and initializes a variable of type <code>String</code>
<code>Guide.InfoWriteLine(message &amp; area)</code>	Calls a function named <code>Guide.InfoWriteLine</code> to write text to the NX Info window. This function lives in the NXOpen namespace, so its full name is <code>NXOpen.Guide.InfoWriteLine</code> . We can use the shortened name here because we wrote " <code>Imports NXOpen</code> " above
<code>' Function to calculate circle area</code>	This is a "comment". Comments are descriptive text to help you and other readers understand the code. They are ignored by the compiler.
<code>Function CircleArea(r As Double) As Double</code>	This is the heading for the definition of a function named <code>CircleArea</code> . The text in parentheses says that, when this function is called, it should receive as input a variable of type <code>Double</code> , which will be referred to as " <code>r</code> ". As output, the function will return an item of type <code>Double</code> .
<code>Dim pi As Double = Math.PI</code>	Defines a variable called <code>pi</code> and gives it the value $\pi$ (accurate to around 15 decimal places). The full name of the item on the right is <code>System.Math.PI</code> . But we have <code>Imports System</code> at the top of our file, so we can use the shortened name <code>Math.PI</code> .
<code>Dim area = pi * r * r</code>	Calculates the area, and stores it in a newly declared variable called <code>area</code> . We do not need to write " <code>As Double</code> " because the compiler can infer this.
<code>Return area</code>	Returns the value <code>area</code> as the output of the function

## ■ Lines of Code

Generally, you place one statement on each line of your source file. But you can put several statements on a single line if you separate them by the colon (`:`) character. So, for example, you might write

```
x1 = 3      :   y1 = 5      :   z1 = 7
x2 = 1      :   y2 = 2      :   z2 = 9
```

A statement usually fits on one line, but when it is too long, you can continue it onto the next line by placing a space followed by an underscore character (`_`) at the end of the first line. For example:

```
Dim identityMatrix As Double(,) = { {1, 0, 0}, _
                                     {0, 1, 0}, _
                                     {0, 0, 1} }
```

Actually, in modern versions of Visual Basic, the underscores are often unnecessary, since the compiler can figure out by itself when a line of code is supposed to be a continuation of the one before it.

Note that “white space” (space and tab characters) don’t make any difference, except in readability. The following three lines of code do exactly the same thing, but the first is much easier to read, in my opinion:

```
y = 3.5 * ( x + b*(z - 1) )
y=3.5*(x+b*(z-1))
y      =3.5 * ( x+b * (z - 1) )
```

## Built-In Data Types

In Visual Basic, as in most programming languages, we use variables for storing values. Every variable has a name, by which we can refer to it, and a data type, which determines the kind of data that the variable can hold.

Some of the more common built-in data types are shown in the following table:

Type	Description	Examples	Approximate Range of Values
Integer	A whole number	1, 2, 999,-2, 0	-2,147,483,648 through 2,147,483,647
Double	Floating-point number	1.5, -3.27, 3.56E+2	$4.9 \times 10^{-324}$ to $1.8 \times 10^{308}$ , positive or negative
Char	Character	“x”c, “H”c, “山”c	Any Unicode character
String	String of characters	“Hello”, “中山”	Zero up to about 2 billion characters
Boolean	Logical value	True, False	True or False
Object	Holds any type of data		Anything

Note that variables of type **Double** can use scientific notation: the “E” refers to a power of 10, so 3.56E+2 means  $3.56 \times 10^2$ , which is 356, and 3.56E-2 means 0.0356. There are many other built-in data types, including byte, decimal, date, and so on, but the ones shown above are the most useful for our purposes.

## Declaring and Initializing Variables

To use a variable, you first have to declare it (or, this is a good idea, at least). It’s also a good idea to give the variable some initial value at the time you declare it. Generally, a declaration/initialization takes the following form:

```
Dim <variable name> As <data type> = <initial value>
```

So, some examples are:

```
Dim n As Integer = -45
Dim triple As Integer = 3*n
Dim biggestNumberExpected As Integer = 999
Dim diameter As Double = 3.875
Dim companyName As String = "Acme Incorporated"
```

For more complex data types, you use the “New” keyword and call a “constructor” to declare and initialize a new variable, like this:

```
Dim <variable name> As New <data type>(constructor inputs)
```

```
Dim v As New NXOpen.Vector3d(1, 0, 0)
Dim generator As New System.Random()
Dim myButton As New System.Windows.Forms.Button()
```

A variable name may contain only letters, numbers, and underscores, and it must begin with either a letter or an underscore (not a number). Variable names are **NOT** case sensitive, so `companyName` and `CompanyName` are the same thing. Also, variable names must not be the same as Visual Basic keywords (like `Dim` or `Integer`).

There are some ways to omit or shorten variable declarations, as explained in the next section.

## ■ Omitting Variable Declarations

When you're just experimenting with small programs, declaring variables is sometimes not very helpful, and the extra typing and text just interfere with your thought process. If you put [Option Explicit Off](#) at the beginning of your program, then this will prevent the compiler from complaining about missing declarations, and this might make your life easier (for a while, anyway). On the other hand, as we saw in chapter 3, declaring variables helps the compiler find mistakes for you, so it's valuable.

When you write [Option Explicit Off](#), the compiler doesn't know the types of undeclared variables, so it assumes that they are all of type `System.Object`. As we will see later, all objects in Visual Basic are derived (either directly or indirectly) from `System.Object`, so a variable of this type can hold any value whatsoever, and any assignment statement will work, no matter how peculiar:

```
vec = 3.75           ' vec is of type System.Object
vec = "hello"       ' so this strange assignment works
vec = New Vector3d(2,3,7) ' and so does this
x = vec.X           ' this works, too, but we get no help from Intellisense
```

When a variable is of type `System.Object`, you don't get much help from Visual Studio Intellisense. When you type the dot in the fourth line of code above, you might be hoping to see a helpful list of the properties of a `Vector3d` object, but you won't, because the compiler thinks that `vec` is a `System.Object`, not a `Vector3d`.

If you get tired of declaring variables, but you still want the compiler to find your mistakes, and give you helpful Intellisense hints, then a good compromise is [Option Infer On](#). With this option, the compiler tries to guess the type of a variable, based on its initialization or first usage. The code looks like this:

```
Dim x = 3.75           ' Compiler guesses that x is of type Double
Dim y = Math.SinD(x)   ' Compiler guesses that y is of type Double
Dim greeting = "hello" ' Compiler guesses that greeting is of type String
Dim vec = Vector3d(2,3,4) ' Compiler guesses that vec is of type NXOpen.Vector3d
Dim x = vec.X          ' Intellisense helps us, now
```

The word `Dim` before a variable is what prompts the compiler to start guessing. You are still declaring the variables `x`, `y`, `greeting`, and `vec`, but you don't have to tell the compiler their types, because it can guess from the context. This can cut down on a lot of repetition, and make your code much easier to read. In the following, the second three lines of code are much clearer than the first three, and just as safe:

```
Dim p1 As NXOpen.Point3d = New NXOpen.Point3d(2,3,4)
Dim q1 As NXOpen.Point3d = New NXOpen.Point3d(7,5,9)
Dim a1 As NXOpen.Line = workPart.Curves.CreateLine(p1, p1)

Dim p1 = New NXOpen.Point3d(2,3,4)
Dim q1 = New NXOpen.Point3d(7,5,9)
Dim a1 = workPart.Curves.CreateLine(p1, p1)
```

In the examples later in this document, we will sometimes use [Option Infer On](#) to make the code shorter and easier to read.

You have to be a little careful, sometimes, because the guessing isn't foolproof. Consider the following code:

```
Dim x = 5           ' Compiler assumes that x is an Integer
x = System.Math.PI ' Error or unwanted rounding
```

The compiler will infer that `x` is an Integer. So, in the second line of code, we're trying to assign a Double value to an Integer variable, and we'll either get an error message, or the value of `x` will be rounded to 3 (instead of 3.14159...) when it's stored in the variable `x`. To avoid this sort of problem, you can write `Dim x = 5.0` in the first line, which will tell the compiler that `x` is supposed to be a Double.

## ■ Data Type Conversions

Conversion is the process of changing a variable from one type to another. Conversions may either be *widening* or *narrowing*. A widening conversion is a conversion from one type to another type that is guaranteed to be able to contain it (from Integer to Double, for example), so it will never fail. In a narrowing conversion, the destination variable may not be able to hold the value (an Integer variable can't hold the value 3.5), so the conversion may fail. Conversions can be either *implicit* or *explicit*. Implicit conversions occur without any special syntax, like this:

```
Dim weightLimit As Integer = 500
Dim weight As Double = weightLimit      ' Implicit conversion from Integer to Double
```

Explicit conversions, on the other hand, require so-called “cast” operators, as in the following examples.

```
Dim weight As Double = 500.637
Dim roughWeight As Integer
roughWeight = CInt(weight)              ' Cast weight to an integer (rounding occurs)
roughWeight = CType(weight, Integer)    ' Different technique, but same result
```

You can perform casts with the general `CType` function, or with more specific functions like `CInt`. The result is exactly the same — the weight value is rounded and we get `roughWeight = 501`.

The set of allowable implicit conversions depends on the `Option Strict` setting. If you use `Option Strict On`, only widening conversions may occur implicitly. With `Option Strict Off`, both widening and narrowing conversions may occur implicitly.

## ■ Arithmetic and Math

Arithmetic operators are used to perform the familiar numerical calculations on variables of type Integer and Double. The only operator that might be slightly unexpected is “^”, which performs exponentiation (raises a number to a power). Here are some examples:

```
Dim m As Integer = 3
Dim n As Integer = 4
Dim p1, p2, p3, p4, p5 As Integer
p1 = m + n          ' p1 now has the value 7
p2 = 2*m + n - 1    ' p2 now has the value 9
p3 = 2*(m + n) - 1  ' p3 now has the value 13
p4 = m / n          ' p4 now has the value 1. Beware !!
p5 = m ^ n          ' p5 now has the value 81
```

Even though `m` and `n` are both integers, performing a division produces a `Double` (0.75) as its result. But then when you assign this value to the `Integer` variable `p4`, it gets rounded to 1. With either `Integer` or `Double` data types, dividing by zero will cause trouble, of course.

The `System.Math` namespace contains all the usual mathematical functions, so you can write things like:

```
Dim rightAngle As Double = System.Math.PI / 2
Dim cosine As Double = System.Math.Cos(rightAngle)
Dim x, y, r, theta As Double
theta = System.Math.Atan2(3, 4)      ' theta is about 0.6345 (radians)
x = System.Math.Cos(theta)           ' x gets the value 0.8
y = System.Math.Sin(theta)           ' y gets the value 0.6
r = System.Math.Sqrt(x*x + y*y)
```

Note that the trigonometric functions expect angles to be measured in radians, not in degrees.

Other useful tools include hyperbolic functions (`Sinh`, `Cosh`, `Tanh`), logarithms (`Log` and `Log10`), and absolute value (`Abs`). Visual Studio Intellisense will show you a complete list as you type.

In floating point arithmetic (with `Double` variables), small errors often occur because of round-off. For example, calculating  $0.1+0.1+0.1+0.1+0.1+0.1+0.1+0.1+0.1+0.1$  (10 times) won't give you 1.0, you'll get 0.9999999999999999, instead. Tiny errors like this usually don't matter in engineering applications. But, in cases where they do, you can use the `Decimal` data type, instead of `Double`. Arithmetic is much slower with `Decimal` variables, but more precise.

## ■ Logical Values & Operators

Visual Basic provides a set of relational operators that perform some comparison between two operands and return a `Boolean` (true or false) result. Briefly, these operators are, `=`, `<`, `>`, `<=`, `>=`, `<>`. Their meanings are fairly obvious, except perhaps for the last one, which means "is not equal to".

Also, there are some logical operators that act on Boolean operands. They are:

- **And**: the result is `True` when both of the operands are `True`
- **Or**: the result is `True` when at least one of the operands is `True`
- **Xor**: the result is `True` when exactly one of the operands is `True`
- **Not**: this is a unary operator. The result is `True` if the operand is `False`

Using these operators, we can construct complex conditions for use in If statements and elsewhere:

```
Dim four As Integer = 4
Dim five As Integer = 5
Dim six As Integer = 6
Dim m, n As Integer
Dim b1, b2, b3, b4, b5, b6 As Boolean

b1 = (four = five)           ' Result is False
b2 = (six < five)           ' Result is False
b3 = (four <> five)         ' Result is True
b4 = ("four" < "five")     ' Result is False. String comparison is alphabetical !
b5 = (four < five) And (five < six) ' Result is True
b6 = (m < n) Or (m >= n)   ' Result is True (regardless of values of m and n)
```

## ■ Arrays

An array is a collection of values that are related to each other in some way, and have the same data type. Within an array, you can refer to an individual element by using the name of the array plus a number. This number has various names: index, offset, position, or subscript are some common ones. The term "offset" is perhaps the best, since it highlights the fact that the numbering starts at zero — the first element of the array has an offset of zero.

In the following code, the first line declares and initializes an array variable that holds the number of people who work on each floor of an office building. It says that 5 people work on the ground floor, 27 on the first floor, and so on. Then the second and third lines read values from the people array.

```
Dim people As Integer() = {5, 27, 22, 31}
Dim groundFloorPeople As Integer = people(0) ' 5 people work on the ground floor
Dim firstFloorPeople As Integer = people(1) ' 27 people work on the first floor
```

Note that the style of array declaration shown here is perfectly legal, but it is not the usual one. Most VB programmers would write `Dim people() As Integer`, but I think the style shown above makes more sense — it says that people is an `Integer()` (i.e. it is an `Integer` array). If you want to declare and initialize the array separately, then you write something like:

```
Dim people As Integer()      ' Declares people as an array of integers
people = New Integer(3) {}   ' Initialises the "people" array variable
people(0) = 5                ' Initialise the elements of the array, one by one
people(1) = 27
people(2) = 22
people(3) = 31
```

In this case, you need to place an integer between the parentheses in the declaration. Note that the number you use is the upper bound of the array (the highest index), which is one less than the number of elements in the array. So, in the example above, the “`New Integer(3)`” gave us an array of **four** integers with indices 0, 1, 2, 3. If you have experience with C-style programming languages, this can be very confusing, so please beware.

You can also create two-dimensional (and higher dimension) arrays using declarations like

```
Dim identityMatrix As Double(,) = { {1,0,0}, {0,1,0}, {0,0,1} }
```

The .NET framework provides many useful functions for working with arrays. For example:

- The `Length` property returns the total number of elements in the array
- The `GetUpperBound` method returns the highest index value for the specified dimension
- The `Sort` method sorts the elements of a one-dimensional array
- The `Find` and `FindIndex` methods allow you to search for specific items

## ■ Other Types of Collections

The .NET Framework includes the `System.Collections` namespace, which provides many useful “collections” that are more general than the arrays described above. For example, there are Lists, Dictionaries (Hash Tables), Queues, Stacks, and so on. You should use a List (rather than an array) when you don’t know in advance how many items you will need to store. Here is a simple example:

```
Dim nameList As New List(Of String)      ' Create a list of strings
Dim name As String
Do                                       ' Loop to collect names
    name = GetName()                   ' Get the next name, somehow
    nameList.Add(name)                 ' Add it to our list
Loop Until name = ""                   ' Keep going until a blank name is encountered
```

There is also a general collection called an `ArrayList`, which can hold elements of different types. So, you can write:

```
Dim myList As New ArrayList
myList.Add("apple pie")
myList.Add(System.Math.PI)
Dim x as Double = myList(1)           ' Gives x the value 3.14159625 etc.
```

Like a List, an `ArrayList` expands dynamically as you add elements. Though the `ArrayList` type is more general, you should use the `List` type, where possible, since it is faster and less error-prone. Most of the “collection” types support the same capabilities as arrays, such as indexing, counting, sorting, searching, and so on.

## ■ Strings

A `String` is essentially an array of characters. You can declare and initialize a string with one statement like:

```
Dim myString As String = "Hello, World!"
```

You can extract characters from a [String](#) just as if it were an array of characters:

```
Dim alphabet As String = "ABC"
Dim c0 As Char = alphabet(0) ' Sets c0 equal to "A"
Dim c1 As Char = alphabet(1) ' Sets c1 equal to "B"
Dim c2 As Char = alphabet(2) ' Sets c2 equal to "C"
```

You can “concatenate” two strings (join them together into one) using either the “+” or “&” operators. Also, there are many useful functions available for working with strings; some of them are: [Trim](#), [ToUpper](#), [ToLower](#), [SubString](#), [StartsWith](#), [Compare](#), [Copy](#), [Split](#), [Remove](#) and [Length](#). For example:

```
Dim firstName As String = "Jonathon"
Dim lastName As String = "Smith"
Dim nickName As String = firstName.Substring(0, 3) ' Sets nickName = "Jon"
Dim fullName As String = firstName & " " & lastName ' Sets fullName = "Jonathon Smith"
Dim greeting As String = "Hi, " & nickName ' Sets greeting = "Hi, Jon"
```

Strings are immutable, which means that once you assign a value to one, it cannot be changed. Whenever you assign another value to a string, or edit it in some way, you are actually creating a new copy of the string variable and deleting the old one. If you are doing a lot of modifications to a string variable, use the [StringBuilder](#) type, instead, because it avoids this deletion/recreation and gives much better performance.

Any .NET object can be converted to [String](#) form using the [ToString](#) method. So, for example, this code

```
Dim pi As Double = System.Math.PI
Dim piString As String = pi.ToString
```

will place the string “3.14159265358979” in the variable [piString](#).

## ■ Enumerations

Enumerations provide a convenient way to work with sets of related constants. You can give names to the constants, which makes your code easier to read and modify. For example, in NX Open, there is an enumeration that represents the various types of line font that can be assigned to an object. In shortened form, its definition might look something like this:

```
Enum ObjectFont
    Solid = 0
    Dashed = 1
    Dotted = 2
End Enum
```

Having made this definition, the symbol [ObjectFont.Dotted](#) now permanently represents the number 2. The benefit is that a statement like [myFont = ObjectFont.Dotted](#) is much easier to understand than [myFont = 2](#).

## ■ Nothing

Some of the data types we have discussed above can have a special value called [Nothing](#) (or “null” in some other programming languages). For example, strings, arrays, and objects can all have the value [Nothing](#). Visual Basic provides a special function called [IsNothing](#) to make it easy to test for this value. Note that [Nothing](#) does not indicate a string with no characters, or an array with zero length, as the following code illustrates:

```
Dim nullString As String = Nothing ' A String variable with value = Nothing
Dim zeroLengthString As String = "" ' A String with zero length (no characters)

Dim b1 As Boolean = IsNothing(nullString) ' True
Dim b2 As Boolean = IsNothing(zeroLengthString) ' False
```

Simple data types like `Integer`, `Double`, `Vector3d` and `Point3d` cannot have the value `Nothing`, ordinarily — there is no such thing as a null integer or a null `Point3d`. This is actually quite inconvenient, at times. For example, in a function that computes the point of intersection of two curves, it would be natural to return `Nothing` if the curves don't actually intersect. Fortunately, recent versions of Visual Basic provide a solution via a technology called “nullable value types”: by placing a question mark (?) after a variable type, you can indicate that it should be allowed to hold the value `Nothing`, in addition to its “regular” values. Then you can use the `HasValue` function to find out whether or not the variable holds a “real” value, rather than `Nothing`. Actually, `Point3d?` is an abbreviation for `Nullable(Of Point3d)`, and you may see the longer form in documentation, sometimes.

## ■ Decision Statements

Simple decisions can be implemented using the `If Then Else` construct, as shown in the following tax computation. It assumes that we have already defined two variables called `income` and `tax`

```
If income < 27000 Then
    tax = income * 0.15           ' 15% tax bracket
ElseIf income < 65000 Then
    tax = 4000 + (income - 27000) * 0.25   ' 25% tax bracket
Else
    tax = 4000 + (income - 65000) * 0.35   ' 35% tax bracket
End If
```

If there were only two tax brackets, we wouldn't need the `Elseif` clause, so our code could be simpler:

```
If income < 27000 Then
    tax = income * 0.15           ' 15% tax bracket
Else
    tax = 4000 + (income - 65000) * 0.35   ' 35% tax bracket
End If
```

This could be simplified even further:

```
tax = income * 0.15           ' 15% tax bracket
If income > 27000 Then
    tax = 4000 + (income - 65000) * 0.35   ' 35% tax bracket
End If
```

Finally, we can compress the `If` statement into a single line, if we want to:

```
If income > 27000 Then tax = 4000 + (income - 65000) * 0.35           ' 35% tax bracket
```

## ■ Looping

It is often useful to repeat a set of statements a specific number of times, or until some condition is met, or to cycle through some set of objects. These processes are all called “looping”. The most basic loop structure is the `For ... Next` loop, which takes the following form

```
For i = 0 To n
    a(i) = 0.5 * b(i)
    c(i) = a(i) + b(i)
Next
```

The variable `i` is called the loop counter. The statements between the `For` line and the `Next` line are called the body of the loop. These statements are executed `n+1` times, with the counter `i` set successively to 0, 1, 2, ..., `n`. It is often convenient to declare the counter variable within the `For` statement. Also, you can append the name of the counter variable to the `Next` statement, which sometimes improves clarity, especially in “nested” loops like this:



```

For i As Integer = 0 To m
  For j As Integer = 0 To n
    c(i, j) = a(i) + b(j)
  Next j
Next i

```

Several other looping constructs are available, including:

- The `For Each...Next` construction runs a set of statements once for each element in a collection. You specify the loop control variable, but you do not have to determine starting or ending values for it.
- The `Do...Loop` construction allows you to test a condition at either the beginning or the end of a loop structure. You can also specify whether to repeat the loop while the condition remains True or until it becomes True.

## ■ Functions and Subroutines

In many cases, you will call a “function” to perform some task. For example, you call the `Math.Sqrt` function to calculate the square root of a number, or you call the NX Open `CreatePoint` function to create a Point. Sometimes the function is one that you wrote yourself, but, more often, it’s part of some library of functions written by someone else (like NX Open). You pass inputs to a function when you call it, the code inside the function is executed, and then (sometimes) it returns some value to you as output. The function provides a convenient place to put a block of code, so that it’s easy to re-use. Here are some examples of function calls:

```

' Some calls to the Math.Sqrt function
Dim x, y, z As Double
x = 3
y = Math.Sqrt(x)
z = Math.Sqrt(5)
Dim root2 As Double = Math.Sqrt(2)

' Some calls to the NXOpen.Guide.InfoWriteLine function
Dim greeting As String = "Hello"
NXOpen.Guide.InfoWriteLine(greeting)
NXOpen.Guide.InfoWriteLine("Goodbye")

' Some more calls to NXOpen functions
Dim p As New NXOpen.Point3d(3, 5, 7)
workPart.Points.CreatePoint(p)

```

In Visual Basic, a function that does not return a value is called a “Subroutine” or just a “Sub”. In the code above, `NXOpen.Guide.InfoWriteLine` is a subroutine, but `Math.Sqrt` and `CreatePoint` are not. Even if a function does return a value, you are not obligated to use this value. For example, in the code above, we didn’t use the value returned from the `CreatePoint` function. A function can have any number of inputs (or “arguments”) including zero.

Near the start of this chapter, we saw an example of a function (`CircleArea`) that you might have written yourself:

```

Function CircleArea(r As Double) As Double
  Dim pi As Double = 3.14
  Dim area As Double = pi * r * r
  Return area
End Function

```

Since you have the source code of this function, you could just use this code directly, instead of calling the function, but we would not recommend this approach; calling functions makes your code less repetitive, easier to read, and easier to change. The general pattern for a function definition is:

```

Function <FunctionName>(arguments) As <ReturnType>
  <body of the function>
End Function

```

Some further examples are:

```

Function RectangleArea(width As Double, height As Double) As Double      ' Area of a rectangle
Function Average(m As Double, n As Double) As Double                    ' Average of two numbers
Function Average(values As Double()) As Double                          ' Avg of list of numbers
Function Cube(center As Position, size As Double) As NXOpen.Body        ' Create a cube

```

Note that it's perfectly legal to have several functions with the same name, provided they have different types of inputs. This technique is called “overloading”, and the function name is said to be “overloaded”. For example, the function name “Average” is overloaded in the list of function definitions above. When you call the function, the compiler will decide which overload to call by looking at the types of inputs you provide.

## ■ Classes

In addition to the built-in types described earlier, Visual Basic allows you to define new data types of your own. The definition of a new user-defined data type is held in a block of code called a class. The class represents a generic object, and a specific concrete object of this type is called an “instance” of the class. So, for example, we might have a “Sphere” class that represents spheres in general, and the specific sphere object with center at (0,0,0) and radius = 3 would be an instance of this Sphere class.

New objects defined by classes have **fields**, **properties** and **methods**. Fields and properties can be considered as items of data (like the radius of a sphere), and a method is a function that does something useful with an object of the given class (like calculating the volume of a sphere). Properties are described in the next section, but, for now, you can think of a property as just a field with a smarter and safer implementation — it provides controlled read/write access to a hidden field.

A class typically includes one or more functions called “constructors” that are used to create new objects. So, a typical class definition might look like this:

```

Public Class Ball

    Public Center As Position      ' Field to hold center point (should be a property, really)
    Public Radius As Double        ' Field to hold radius value (should be a property, really)

    ' Constructor, given a position and a radius
    Sub New(center As Position, r As Double)
        Me.Center = center
        Me.Radius = r
    End Sub

    ' Constructor, given center coordinates and radius
    Sub New(x As Double, y As Double, z As Double, r As Double)
        MyClass.New(New Position(x, y, z), r)
    End Sub

    ' Function (method) to calculate volume
    Public Function Volume() As Double
        Return (4 / 3) * System.Math.PI * Me.Radius ^ 3
    End Function

    ' Function (method) to draw a ball
    Public Sub Draw()
        ' Code omitted
    End Sub

End Class

```

Note that the constructors are “overloaded” — there are two of them, with different inputs. To create a **Ball** object, you call a constructor using the **New** keyword. Properties and methods are both accessed using a “dot” notation. As soon as you type a period in Visual Studio, Intellisense will show you all the available fields, properties and methods.

In this class, [Center](#) and [Radius](#) are both public fields, so you can access them directly. It would be safer to make them private fields and provide properties to access them. By doing this, we could prevent the calling code from making balls with negative radius, for example. Code to use the [Ball](#) class looks like this:

```
Dim myBall As New Ball(x, y, z, r)           ' Create a ball named "myBall"  
myBall.Radius = 10                          ' Change its Radius property (or field)  
Dim mass As Double = density * myBall.Volume() ' Use the Volume method  
myBall.Draw                                 ' Display the ball
```

Note that the first line of code uses a convenient shorthand notation. The full form would have been

```
Dim myBall As Ball = New Ball(x, y, z, r)
```

Also, note how empty parentheses can simply be omitted when you call a function that has no arguments: so, we wrote [myBall.Draw](#) instead of [myBall.Draw\(\)](#). Similarly, in the line above, we could have just written [myBall.Volume](#).

## ■ Shared Functions

In the example above, we had a class called “Ball”, and this class contained functions (methods) like [Volume](#) and [Draw](#) that operated on balls. This is the “object-oriented programming” view of life — the world is composed of objects that have methods operating on them. This is all very nice, but some software doesn’t fit naturally into this model. Suppose for example that we had a collection of functions for doing financial calculations — for calculating things like interest, loan payments, and so on. The functions might have names like [SimpleInterest](#), and [LoanPayment](#), etc. It would be natural to gather these functions together in a class named [FinanceCalculator](#). But the situation here would be fundamentally different from the “ball” class. The [SimpleInterest](#) function lives in the [FinanceCalculator](#) class, but it doesn’t operate on [FinanceCalculator](#) objects. Saying it another way, the [SimpleInterest](#) function is associated with the [FinanceCalculator](#) class itself, not with instances of the [FinanceCalculator](#) class.

Functions like this are called “Shared” functions in Visual Basic (or “static” functions in many other languages). You have already seen this word many times before because the “Main” function is always [Shared](#). By contrast, the functions [Volume](#) and [Draw](#) in the [Ball](#) class are called Member functions or Instance functions. So, in short, the [FinanceCalculator](#) class is simply a collection of [Shared](#) functions. This is a common situation, so Visual Basic has a special construct to support it — a class that consists entirely of [Shared](#) functions is called a Module.

Calls to Member functions and Shared functions look the same in our code, but they are conceptually different. For example, look at:

```
Dim myBall As New Ball(x, y, z, r)  
Dim v As Double = myBall.Volume()  
Dim payment As Double = FinanceCalculator.LoanPayment(20000, 4.5)
```

Both the second and third lines use the “dot” notation to refer to a function. But, in these two cases, the thing that comes before the “dot” is different. In [myBall.Volume](#) on the second line, [myBall](#) is an object (of type [Ball](#)), but in [FinanceCalculator.LoanPayment](#) on the third line, [FinanceCalculator](#) is a class.

## ■ Object Properties

Each type of object we create in a VB program typically has a set of “properties” that we can access. For example, a point has a position in space, an arc has a center and a radius, a curve has a length, and a solid body has a density. In all cases, you can read (or “get”) the value of the property, and in many cases, you can also write (or “set”) the value. Setting a property value is often a convenient way to modify an object.

If you are familiar with the GRIP language, these properties are exactly analogous to GRIP EDA (entity data access) symbols.

Each property has a name. To get or set the property, you use a “dot” followed by the name of the property. So, if [myCircle](#) is an arc, then you refer to its center as [myCircle.Center](#), and its radius as [myCircle.Radius](#).

If `p1`, `p2`, `p3` are three given positions, then (conceptually) we can write code like this:

```
c1 = Circle(p1, p2, p3) ' Creates a circle through three positions p1, p2, p3
r = c1.Radius          ' Gets the radius of the circle
c1.Center = p2        ' Moves the circle, placing its center at position p2
```

## ■ Hierarchy & Inheritance

Object methods and properties are hierarchical. In addition to its own particular properties, a given object also has all the properties of object types higher up in the object hierarchy. So, for example, since a `Line` is a kind of `Curve`, it has all the properties and methods of the `Curve` type, in addition to the particular ones of lines. We say that the `Line` type “inherits” properties and methods from the `Curve` type. A portion of the hierarchy is shown below:

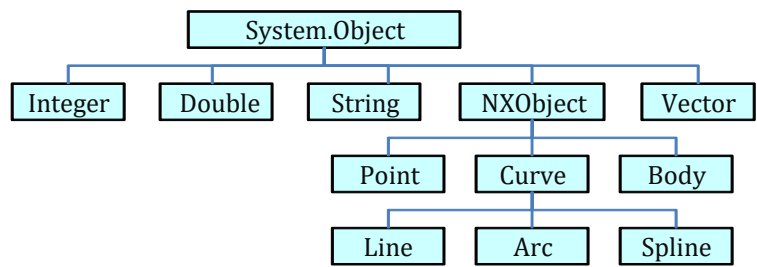

As you can see, every object is derived from `System.Object`, and therefore inherits certain mysterious properties from it (like the `Finalize`, `GetHashCode`, and `MemberwiseClone` functions). The tables in the following chapters indicate the types of objects we will be using, and their properties. You might think you will need to keep these tables handy as you are writing code, so that you know what properties are available. But, this is not the case assuming you are using a modern IDE (Integrated Development Environment) to write your code. In a good IDE (like Visual Studio), as soon as you type a dot, a list of available properties and methods will appear, and all you have to do is choose the one you want. Some enthusiasts like to say that “the code writes itself” 😊

# Chapter 5: Concepts & Architecture

This chapter describes the overall structure of NX Open, and some of the underlying principles. The standard NX Open Reference Guide tells you how to call any of the thousands of functions available in NX Open, but many people find it hard to see the “big picture”, so they don’t know where to start. This chapter explains the conceptual model behind NX Open programming, to make it easier to find the functions you need.

## ■ The Levels of NX Open

The programming interfaces for NX have evolved over many years. Earlier generations are still supported and still work, even though they have been superseded by newer APIs and are no longer being enhanced. These older tools included an API called “User Function” or “UFUNC” that was designed to support applications written in the Fortran or C languages. The name of the User Function C API was subsequently changed, and it is now known as the NX Open C API, or sometimes just the Open C API. This API is old-fashioned, by today’s standards, but it is extremely rich, fairly well documented, and still widely used. A large part of the NX Open .NET API (a portion called the `NXOpen.UF` namespace) was actually created by building “wrappers” around NX Open C functions. The `NXOpen.UF` functions are not used in recorded journals, so it’s easy to forget about them, but they are very useful. Newer NX Open .NET functions are built directly on top of internal NX functions, so they by-pass the NX Open C layer. The `SNAP` layer is built on top of NX Open .NET.

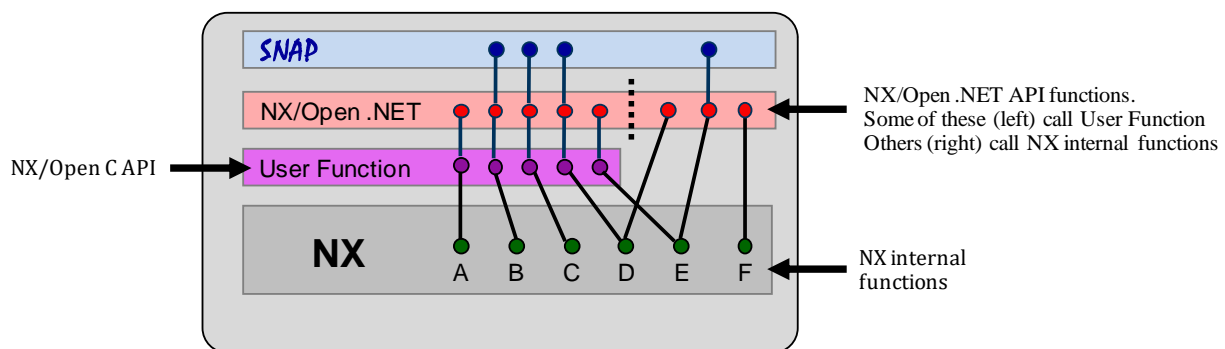

## ■ More About NXOpen.UF

As mentioned above, there are many useful functions in the `NXOpen.UF` namespace. Some examples are:

- `NXOpen.UF.Curve`: many functions for working with curves
- `NXOpen.UF.Disp`: display functions (colors, grids, view names, etc.)
- `NXOpen.UF.Draw`: functions for working with drawings and drawing views
- `NXOpen.UF.Drf`: functions for working with drafting objects like dimensions
- `NXOpen.UF.UFEval`: information about curves and surfaces (points, tangents, normal, etc.)
- `NXOpen.UF.UFModl`: a large number of part modeling functions
- `NXOpen.UF.UFPath`: functions for working with NC toolpaths
- `NXOpen.UF.UFSf`: functions for working with finite element models (nodes, elements, meshes)

You can use these functions alongside the newer functions, but mixing requires some simple conversions, as explained later in this chapter in the section entitled “[Objects and Tags](#)”.

## ■ The NX Open Inheritance Hierarchy

As in most modern software systems, NX object classes are arranged in a hierarchical structure, with lower-level items inheriting from higher-level ones. There are hundreds of different object types, so the complete picture is difficult to understand (or even to draw). The simplified diagram below shows us the path from the top of the hierarchy down to some of the simple commonly-used objects.



So, we see that a Point is a kind of “SmartObject”, which is a kind of “DisplayableObject”, and so on. The details are given later, but briefly, here are the roles of the more important object types:

### RemotableObject

Used for collections of preferences and also as the basis of the “UF” classes

### TaggedObject

Used for lists of objects, for selections, and for “builders” (to be described later)

### NXObject

Used for Part objects, and for objects that live inside NX part files, but are not displayed — views, layouts, expressions, lights, and so on. NXObjects have names and other non-graphical attributes.

### DisplayableObject

Includes most of the object types familiar to users. Things like annotations, bodies, faceted bodies, datum objects, CAE objects. Displayable objects have colors, fonts, and other appearance attributes. Note that NX features are not displayable objects.

### SmartObject

Includes points, curves, and some object types used as components of other objects when implementing associativity.

## ■ Sessions and Parts

Typical NX objects (the ones we’re discussing, here, anyway) reside in part files. So, if we want to create a new object, the first thing we must do is identify a part file in which this object will be created. Very often, you will want to create new objects in the current work part, so the required code is:

```
Dim mySession As NXOpen.Session = NXOpen.Session.GetSession ' Get the current NX session
Dim parts As NXOpen.PartCollection = mySession.Parts ' Get the session's PartCollection
Dim workPart As NXOpen.Part = parts.Work ' Get the Work Part
```

As you can see, we first get the current NX session object by calling the GetSession function. Every session object has a PartCollection object called “Parts” which we obtained in the second line of code. Then we get the Work Part

from this PartCollection. Of course, as always, we could have reduced our typing by putting `Imports NXOpen` at the top of our code file.

In addition to the Work Part, there are other useful objects that you will probably want to initialize at the beginning of your program. Examples are the Display Part, the “UI” object, the “Display” object, the UFSession object, and so on. So, you will see code like this near the top of many NX Open programs:

```
Dim theSession As NXOpen.Session = NXOpen.Session.GetSession
Dim theWorkPart As NXOpen.Part = theSession.Parts.Work
Dim theDisplayPart As NXOpen.Part = parts.Display
Dim theUfSession As NXOpen.UF.UFSession = NXOpen.UF.UFSession.GetUFSession
Dim theDisplay As NXOpen.DisplayManager = theSession.DisplayManager
Dim theUI As NXOpen.UI = NXOpen.UI.GetUI
```

## ■ Objects and Tags

As we mentioned earlier, there are many useful functions in the NXOpen.UF namespace. But the NXOpen.UF functions do not use the object types described earlier; they use object “tags” instead. Typical code looks like this:

```
Dim coords As Double() = { 1.5, 2.5, 7 }
Dim pointTag As NXOpen.Tag
theUfSession.Curve.CreatePoint(coords, pointTag)
theUfSession.Obj.SetLayer(pointTag, 30)
```

Notice how the `CreatePoint` function does not return an NXOpen.Point object, it returns the NXOpen.Tag (`pointTag`) of the point it created. Then, whenever we want to refer to this point in subsequent code, we use this tag. So, for example, in the last line of code, `pointTag` is used as input to the `SetLayer` function.

We can contrast this with code that does the same operations using newer object-based functions:

```
Dim coordsPt As New NXOpen.Point3d(1.5, 2.5, 7)
Dim myPoint As NXOpen.Point = theWorkPart.Points.CreatePoint(coordsPt)
myPoint.Layer = 30
```

Of course, there will be times when you want to use a mixture of NXOpen.UF functions and newer ones, so it’s important to understand how objects and tags relate to one another. In one direction, the correspondence is very simple: if you have an NX object called `myObject`, then `myObject.Tag` gives you its tag. So, we could do this:

```
Dim myPoint As NXOpen.Point = theWorkPart.Points.CreatePoint(coordsPt)
Dim pointTag As NXOpen.Tag = myPoint.Tag
theUfSession.Obj.SetLayer(pointTag, 30)
```

In the opposite direction (from tag to object), the process is slightly more complicated:

```
Dim pointTag As NXOpen.Tag
theUfSession.Curve.CreatePoint(coords, pointTag)
Dim obj As NXOpen.TaggedObject = NXOpen.Utilities.NXObjectManager.Get(pointTag)
Dim myPoint As NXOpen.Point = CType(obj, NXOpen.Point)
myPoint.Layer = 30
```

As you can see, calling the `NXObjectManager.Get` function gives us an NXOpen.TaggedObject, and then we cast this to type NXOpen.Point. In practice, you would probably shorten this by using an implicit cast, like this:

```
Dim myPoint As NXOpen.Point = NXOpen.Utilities.NXObjectManager.Get(pointTag)
```

## ■ Factory Objects

In NX Open, an object is usually not created by calling a constructor function. Instead, you use a “create” function that is a member function of some “factory” object. The “factory” concept is well-known in the software engineering field — just as in real life, a factory is a place where you produce new items. Different types of objects use different types of factories. Typically you can get a suitable factory object from an `NXOpen.Part` object (usually the work part), or from an `NXOpen.Session` object. So, suppose for example, that we want to create a point in a part named `myPart`. The relevant factory object is a `PointCollection` object called `myPart.Points`. So, the `CreatePoint` function can be found in the `PointCollection` class, and you use it as follows to create a point:

```
Dim coords As new Point3d(3, 5, 0)           ' Define coordinates of point
Dim points As PointCollection = myPart.Points ' Get the PointCollection of the myPart
Dim p1 As Point = points.CreatePoint(coords) ' Create the point
```

Sometimes the factory object provides functions for directly creating objects, as in the example above. Other times, the factory object provides functions for creating “builder” objects, instead, as discussed in the next section. The following table shows some common examples of factory objects, how you obtain instances of these factory objects, and what sorts of creation functions they provide:

Type of Factory Object	Instance of Factory Object	Example Creation Functions
PointCollection	BasePart.Points	CreatePoint CreateQuadrantPoint
CurveCollection	BasePart.Curves	CreateLine CreateArc CreateEllipse
Features.FeatureCollection	Part.Features	CreateSphereBuilder CreateDatumPlaneBuilder CreateExtrudeBuilder CreateStudioSplineBuilder
Annotations.AnnotationManager	Part.Annotations	CreateNote CreateLabel CreateDraftingNoteBuilder
CAE.NodeElementManager	CAE.BaseFEModel.NodeElementMgr	CreateNodeCreateBuilder CreateElementCreateBuilder
CAM.OperationCollection	CAM.CAMSetup.CAMOperationCollection	CreateHoleMakingBuilder CreateFaceMillingBuilder
CAM.NCGroupCollection.	CAM.CAMSetup.CAMGroupCollection	CreateMillToolBuilder CreateDrillSpotfaceToolBuilder
DexManager	Session.DexManager	CreateIgesImporter CreateStep203Creator
PlotManager	BasePart.PlotManager	CreateCgmBuilder CreatePrintBuilder



Here are some further examples showing factory objects and their simple creation functions:

```
Dim coords As New NXOpen.Point3d(3, 5, 9)
Dim pointFactory As NXOpen.PointCollection = workPart.Points
Dim myPoint = pointFactory.CreatePoint(coords)

Dim p1 As New NXOpen.Point3d(1, 6, 5)
Dim p2 As New NXOpen.Point3d(3, 2, 7)
Dim curveFactory As NXOpen.CurveCollection = workPart.Curves
Dim myLine = curveFactory.CreateLine(p1, p2)

Dim text As String() = { "Height", "Diameter", "Cost" }
Dim origin As New NXOpen.Point3d(3,8,0)
Dim horiz As NXOpen.AxisOrientation = NXOpen.AxisOrientation.Horizontal
Dim noteFactory As NXOpen.Annotations.AnnotationManager
noteFactory = workPart.Annotations
Dim myNote = noteFactory.CreateNote(text, origin, horiz, Nothing, Nothing)
```

In this code, we have explicitly defined the factory objects, to emphasize the role that they play. But, in typical code, they would not be mentioned explicitly, and you'd just write:

```
Dim myPoint = workPart.Points.CreatePoint(coords)

Dim myLine = workPart.Curves.CreateLine(p1, p2)

Dim myNote = workPart.Annotations.CreateNote(text, origin, horiz, Nothing, Nothing)
```

## ■ Object Collections

In many cases, the factory object described in the previous section has the word “collection” in its name. This is because, in addition to its object creation duties, the factory object also provides us with a way of cycling through objects of a specific type in a part file. This is useful if you want to cycle through the objects, performing some operation on each of them. For example, to perform some operation on all the points in a given part file (myPart) you can write:

```
For Each pt As Point In myPart.Points
    ' Do something with pt
Next
```

Speaking more formally, the PointCollection class implements the IEnumerable interface, which means it's a collection of items that you can cycle through using a [For Each](#) loop.

## ■ The Builder Pattern

We saw above how various factory objects provide functions like [CreatePoint](#), [CreateLine](#), and [CreateNote](#) that let us create simple objects directly. However, if we tried to handle more complex objects this way, we would need creation functions with huge numbers of input arguments. To avoid this complexity, we first create a “builder” object, and then we use this to create the object we want. As an example, here is the code to build a sphere feature:

```
[1] Dim nullSphere As NXOpen.Features.Sphere = Nothing
[2] Dim mySphereBuilder As NXOpen.Features.SphereBuilder
[3] mySphereBuilder = workPart.Features.CreateSphereBuilder(nullSphere)
[4] mySphereBuilder.Type = <whatever you want>
[5] mySphereBuilder.Center = <whatever you want>
[6] mySphereBuilder.Diameter = <whatever you want>
[7] mySphereBuilder.BooleanOption.Type = <whatever you want>
[8] Dim myObject As NXOpen.NXObject = mySphereBuilder.Commit
[9] mySphereBuilder.Destroy
```

The code uses the so-called “Builder Pattern”, which is a well-known software engineering technique for creating complex objects. The general approach is to

- Create a “builder” object — line [3]
- Modify its properties as desired — lines [4], [5], [6], [7]
- “Commit” the builder to create a new object — line [8]

So, as we can see, along with the Sphere class, there is a corresponding SphereBuilder class, and a function called CreateSphereBuilder that produces a basic SphereBuilder object. The NX Open Reference Guide will help you find the classes and functions you need. Specifically

- The Sphere class refers you to the SphereBuilder class
- The SphereBuilder class refers you to the CreateSphereBuilder function
- The CreateSphereBuilder function indicates that it is provided by the factory class “FeatureCollection”
- The FeatureCollection class tells you to obtain an instance from a Part object (e.g. workPart.Features)

You can actually use the CreateSphereBuilder function for either creation or editing purposes: if you input an existing Sphere object, then the Commit method will edit this sphere; if you input `Nothing`, then the Commit method will create a new sphere object, as in our code above.

The meanings of the various builder properties that you need to set are fairly obvious in this simple case. But, whenever you’re in doubt about the meaning of a builder property, you can look at the corresponding feature creation dialog in interactive NX. You will see that the builder properties are closely related to the options that appear in the dialog.

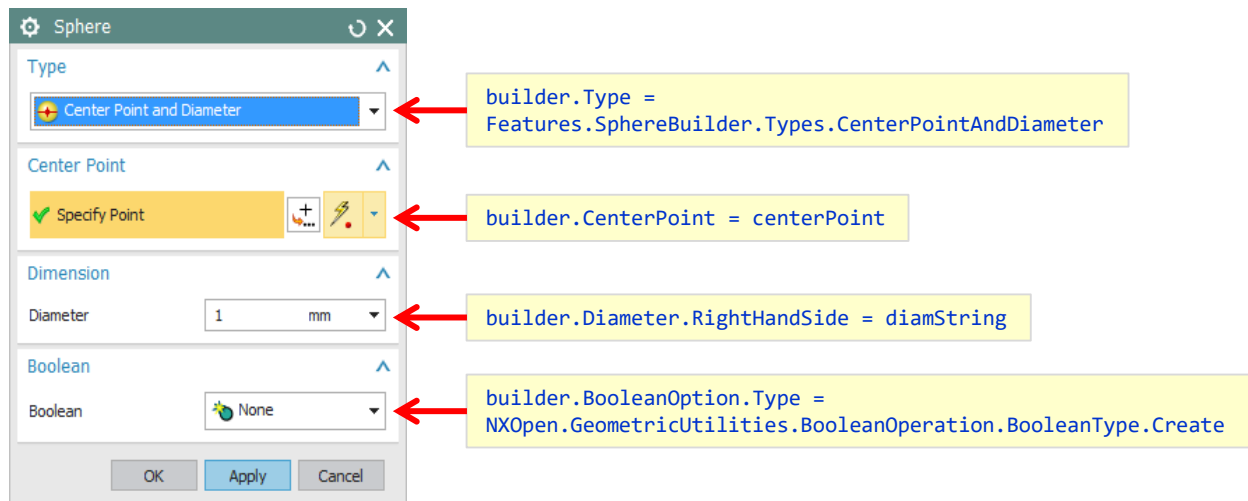

The Commit function returns an `NXOpen.NXObject`, which is not immediately useful, in most situations. You typically have to cast to a more specific type (`NXOpen.Features.Sphere` in our example above) before making further use of the object. Builders for “feature” objects also have a `CommitFeature` method. This returns a very general `NXOpen.Features.Feature` object, so a cast will still be necessary in many cases. You can either perform the cast explicitly, or do it implicitly with an assignment statement, as shown here:

```
' Two steps: commit and explicit cast
Dim myObject As NXOpen.Features.Sphere = builder.Commit
Dim mySphere1 As NXOpen.Features.Sphere = CType(myObject, NXOpen.Features.Sphere)

' One step: commit and cast implicitly
Dim mySphere2 As NXOpen.Features.Sphere = builder.CommitFeature
```

In some cases, both the `Commit` and `CommitFeature` methods return `Nothing`, and you have to use the `GetCommittedObjects` function to obtain the created object(s).

## ■ Exploring NX Open By Journaling

The NX Open API is very rich and deep — it has thousands of available functions. This richness sometimes makes it difficult to find the functions you need. Fortunately, if you know how to use the corresponding interactive function in NX, the journaling facility will tell you which NX Open functions to use, and will even write some sample code for you. You choose Developer tab → Journal → Record to start recording, run through the desired series of steps, and then choose Developer tab → Journal → Stop Recording. The code generated by journaling is verbose and is often difficult to read. But it's worth persevering, because hidden within that code is an example call showing you exactly the function you need. You can indicate which language should be used in the recorded code by choosing File tab → Preferences → User Interface → Tools → Journal. The available choices are C#, C++, Java, Python, and Visual Basic.

## ■ The “FindObject” Problem

When you use a journal as the starting-point for an application program, one of the things you need to do is remove the “FindObject” calls that journaling produces. This section tells you how to do this.

A journal records the exact events that you performed during the recording process. If you select an object during the recording process, and do some operations on it, the journal actually records the name of that object. So, when you replay the journal, the operations will again be applied to this same named object. This is almost certainly not what you want — you probably want to operate on some newly-selected object, not on the one you selected during journal recording. Very often, objects with the original recorded names don't even exist when you are replaying the journal, so you'll get error messages.

To clarify further, let's take a specific example. Suppose your model has two objects in it — two spheres named SPHERE(23) and SPHERE(24). If you record a journal in which you select all objects in your model, and then blank them, then what gets recorded in the journal will be something like this:

```
Dim objects1(1) As DisplayableObject

Dim body1 As Body = CType(workPart.Bodies.FindObject("SPHERE(23)"), Body)
objects1(0) = body1

Dim body2 As Body = CType(workPart.Bodies.FindObject("SPHERE(24)"), Body)
objects1(1) = body2

theSession.DisplayManager.BlankObjects(objects1)
```

If you replay this code, it's just going to try to blank SPHERE(23) and SPHERE(24) again, which is probably useless. There's a good chance that SPHERE (23) and SPHERE (24) won't exist at the time when you're replaying the journal, and, even if they do, it's not likely that these are the objects you want to blank. Clearly we need to get rid of the “FindObject” calls, and add some logic that better defines the set of objects we want to blank. There are a few likely scenarios:

- Maybe we want to blank some objects that were created by code earlier in our application
- Maybe we want to blank some objects selected by the user when our application runs
- Maybe we want to blank all objects in the model, or all the objects that have certain characteristics

The first of these is easy: if we created the objects in our own code, then presumably we assigned them to program variables, and they are easy to identify:

```
Dim myBall0 As NX.Body = Sphere(1,2,1, 5).Body
Dim myBall1 As NX.Body = Sphere(1,4,3, 7).Body

Dim objects1(1) As DisplayableObject

objects1(0) = myBall0
objects1(1) = myBall1

theSession.DisplayManager.BlankObjects(objects1)
```

For the second case, we need to add a selection step to our code as outlined in [chapter 15](#), and then blank the objects the user selects when the journal is replayed. Something like this:

```

Dim cue = "Please select the objects to be blanked"
Dim dialog As Selection.Dialog = Selection.SelectObjects(cue)

Dim result As Selection.Result = dialog.Show

If result.Response <> NXOpen.Selection.Response.Cancel Then
    theSession.DisplayManager.BlankObjects(result.Objects)
End If

```

For the third case (blinking all the objects with certain characteristics), we will need to cycle through all the objects in our model, finding the ones that meet our criteria, and then pass these to the BlankObjects function. See the last section in [chapter 15](#) for information about cycling through the objects in a part file.

## ■ Mixing *SNAP* and NX Open

As we have seen, NX Open functions provide enormous power and flexibility. There is another NX API called SNAP whose functions are usually much easier to find and understand. So, there may well be situations where you will want to use SNAP and NX Open functions together. You can use SNAP functions for simple common operations, and NX Open functions for more complex ones. To do this, you may need to convert SNAP objects into NX Open objects, and vice-versa. We have tried to make these conversions as convenient as possible, so that SNAP and NX Open code can live together in peace and harmony.

A SNAP object is just a simple wrapper around a corresponding NX Open object — for example, a *Snap.NX.Spline* object is just a wrapper that encloses an *NXOpen.Spline*, and a *Snap.NX.Sphere* is a wrapper around an *NXOpen.Features.Sphere* object, and so on. So, if you have an *NXOpen* object, you can “wrap” it to create a *Snap.NX* object. In the other direction, if you have a *Snap.NX* object, you can “unwrap” it to get the *NXOpen* object that it encloses. There are hidden “implicit” conversions that do this wrapping and unwrapping for you, so often things just work without any extra effort. For example:

```

Dim snapPoint As Snap.NX.Point = Point(3,5,9)
Dim session As NXOpen.Session = NXOpen.Session.GetSession
session.Information.DisplayPointDetails(snapPoint)
Dim pt As NXOpen.Point3d = snapPoint.Position

```

In the third line, we are passing a *Snap.NX.Point* object to a function that expects to receive an *NXOpen.Point*. But the implicit conversion is invoked behind the scenes, and the function call just works as expected. Similarly, in the fourth line, we are assigning a *Snap.Position* object to an *NXOpen.Point3d* object, and this works, too.

However, there are times when the implicit conversions don’t work, and you need to do something more explicit. For example, if you want to use *NXOpen* member functions or properties, then you have to get an *NXOpen* object from your *SNAP* object first. So suppose, for example, that we have a *Snap.NX.Sphere* object called *snapSphere*, and we write the following code:

```

snapSphere.HideParents           ' Fails
Dim version = snapSphere.TimeStamp ' Fails

```

Both lines of code will fail, because a *Snap.NX.Sphere* object does not have a *HideParents* method or a *TimeStamp* property. So, to proceed, you have to “unwrap” to get the enclosed *NXOpen.Features.Sphere* object.

You can do this in a couple of different ways, as shown below:

```

CType(snapSphere, NXOpen.Features.Sphere).HideParents ' Works, but a bit clumsy
snapSphere.NXOpenSphere.HideParents                  ' Nicer: use NXOpenSphere property

```

The first line just uses the standard VB *CType* function to do the conversion, and the second line uses the *NXOpenSphere* property. The second approach, using properties, is the most convenient, so there are several

properties that let you get NXOpen objects from SNAP objects in this same way. For example, if `snapSphere` is a `Snap.NX.Sphere` object, again, then

- `snapSphere.NXOpenSphere` is the enclosed `NXOpen.Features.Sphere` object
- `snapSphere.NXOpenTag` is the `NXOpen` tag of this `NXOpen.Features.Sphere` object
- `snapSphere.SphereBuilder` is the “builder” object for the `NXOpen.Features.Sphere`

Going in the other direction (from `NXOpen` to `SNAP`) is not quite so streamlined. The approach using properties is not available, so you have to call the `Wrap` function to create a new `SNAP` object from the `NXOpen` one, like this:

```
Dim coords = New NXOpen.Point3d(3, 6, 8)
Dim workPart As NXOpen.Part = Snap.Globals.WorkPart.NXOpenPart
Dim nxopenPoint As NXOpen.Point = workPart.Points.CreatePoint(coords)
Dim snapPoint As NX.Point = NX.Point.Wrap(nxopenPoint.Tag)      ' Create a Snap.NX.Point
Dim location As Position = snapPoint.Position                    ' Use its Position property
```

In the fourth line of code, we first get the tag of the `NXOpen.Point` object. Then we call the `Wrap` function, which gives us a new `Snap.NX.Point` object that “wraps” it. Then, in the last line, we can use the `Position` property of this new `Snap.NX.Point` object.

As we saw above, the `Wrap` function receives an `NXOpen.Tag` as input. So, if you are working with older `NXOpen` functions that use tags, interoperability with `SNAP` is even easier. For example:

```
Dim ufSession = NXOpen.UF.UFSession.GetUFSession
Dim pointTag As NXOpen.Tag
Dim coords As Double() = {2, 6, 9}
ufSession.Curve.CreatePoint(coords, ByRef pointTag)
Dim snapPoint As NX.Point = NX.Point.Wrap(pointTag)
```

# Chapter 6: Positions, Vectors, and Points

The next few chapters briefly outline the NX Open functions available for performing simple tasks. The function descriptions are fairly brief, since we are just trying to show you the range of functions available. The NX Open Reference Guide has much more detailed information, and this detailed information will also be presented to you as you are writing your code, if you use a good development environment like Visual Studio. Specifically, as soon as you type an opening parenthesis following a function name, a list of function inputs will appear, together with descriptions. You can also get complete information about any function or object by using the Object Browser in Visual Studio.

Following the descriptions of functions, we often give small fragments of example code, showing how the functions can be used. The examples are very simple, but they should still be helpful. To keep things brief, the example code is often not complete. For example, declarations are often left out, and a complete `Main` function is only included very rarely. If you actually want to compile the example code, you will typically need to make some additions.

## ■ Point3d Objects

A `Point3d` object represents a location in 3D space. After basic numbers, positions and vectors are the most fundamental objects in geometry applications, so we will describe them first. There are also `Point2d` and `Point4d` objects, but these are not used as often, so we won't discuss them here. Note that a `Point3d` is not a real NX object. `Point3d` objects only exist in your NX Open program — they are not stored permanently in your NX model (or anywhere else). So, as soon as your program has finished running, all your `Point3d` objects are gone. In this sense, they are just like the numerical variables that you use in your programs. If you want to create a permanent NX object to record a location, you should use an `NXOpen.Point`, not a `Point3d`. You can use the following function to create a `Point3d` object:

Function	Inputs and Creation Method
<code>Point3d(x As Double, y As Double, z As Double)</code>	From three rectangular coordinates.

In the first column, you see a formal description of the types of inputs you should provide when calling the function — you have to provide three variables of type “double”.

This function is a constructor, so, when calling it, we have to use the “New” keyword in our code. Here are some examples:

```
Dim p As New Point3d(3,5,8) ' Creates a Point3d "p" with coordinates (3,5,8)
Dim q As New Point3d (1.7, 2.9, 0) ' Creates a Point3d "q" with coordinates (1.7, 2.9, 0)
```

`Point3d` object properties are as follows:

Data Type	Property	Access	Description
Double	X	get, set	The x-coordinate of the <code>Point3d</code>
Double	Y	get, set	The y-coordinate of the <code>Point3d</code>
Double	Z	get, set	The z-coordinate of the <code>Point3d</code>

## ■ Vector3d Objects

A Vector3d object represents a direction or a displacement in 3D space. Like Point3d objects, Vector3d objects only exist in your NX Open program — they are not stored permanently in your NX model (or anywhere else). You can use the following constructor function to create Vector3d objects:

Function	Inputs and Creation Method
<code>Vector3d(x As Double, y As Double, z As Double)</code>	From three rectangular components.

Vector object properties are as follows:

Data Type	Property	Access	Description
Double	X	get, set	The x-component of the vector
Double	Y	get, set	The y-component of the vector
Double	Z	get, set	The z-component of the vector

The `NXOpen.VectorArithmetic` class provides a Vector3 object that is very similar to `NXOpen.Vector3d`. This class also provides functions for performing operations on Vector3 objects, like addition, subtraction, cross products, and so on. In some cases, it might be convenient to use Vector3 objects for calculations, and then convert the answers to `NXOpen.Vector3d` form for further use. The following code illustrates the approach:

```
Dim u = New NXOpen.VectorArithmetic.Vector3(3,4,7)
Dim v = New NXOpen.VectorArithmetic.Vector3(4,2,1)
Dim w = u + 0.5*v
Dim r = New NXOpen.Vector3d(w.x, w.y, w.z)
```

## ■ Points

Points might seem a lot like Point3d objects, but they are quite different. A Point is an NX object, which is permanently stored in an NX part file; Point3d and Vector3d objects are temporary things that exist only while your NX Open program is running.

To create a point, we write code following the “factory” pattern explained in [chapter 5](#). The basic idea is that a part file contains “collections” of different object types. So, for example, given a Part object named `myPart`, there is a collection called `myPart.Points` that contains all the `Point` objects in the part. Similarly, `myPart.Arcs` is a collection that contains all the arcs in this part, and `myPart.Curves` includes all the curves.

These collections serve as “factory” objects that we can use to create new objects in a part file, as follows:

```
Dim workPart As Part = session.Parts.Work           ' Get the Work Part
Dim points As PointCollection = workPart.Points     ' Get the PointCollection of the Work Part
Dim coords As new Point3d(3, 5, 0)                ' Define coordinates of point
Dim p1 As Point = points.CreatePoint(coords)       ' Create the point (add to collection)
p1.SetVisibility(SmartObject.VisibilityOption.Visible)
```

The last line of code is necessary because an `NXOpen.Point` is a “SmartObject”, which is invisible by default. The code above is written out in a rather verbose way, to allow for complete explanation. In practice, you would typically write something like this:

```
Dim workPart As Part = session.Parts.Work           ' Get the Work Part
Dim coords As new Point3d(3, 5, 0)                ' Define coordinates of point
Dim p1 As Point = workPart.Points.CreatePoint(coords) ' Create the point
p1.SetVisibility(SmartObject.VisibilityOption.Visible) ' Make it visible
```

If you're inclined, you could even create a point with a single line of code, like this:

```
Dim p1 = NXOpen.Session.GetSession.Parts.Work.Points.CreatePoint( New Point3d(3,5,0) )
```

So, in summary, the following function creates a point in a part called myPart:

Function	Inputs and Creation Method
<code>myPart.Points.CreatePoint(x As Double, y As Double, z As Double)</code>	From x, y, z coordinates

The properties of Point objects are as follows:

Data Type	Property	Access	Description
Double	X	get, set	The x-coordinate of the point.
Double	Y	get, set	The y-coordinate of the point.
Double	Z	get, set	The z-coordinate of the point.

There are many functions that require Point3d objects as inputs. If we have a Point, instead of a Point3d, we can always get a Point3d. So, if `pt` is a Point, and we want to set the origin of an `NXOpen.Direction` (which requires a Point3d object), then the necessary code is:

```
myDirection.Origin = New Point3d(pt.X, pt.Y, pt.Z)
```



# Chapter 7: Curves

This chapter briefly outlines the NX Open functions for creating and editing curves (lines, arcs, and splines). For further details, please look at the [NXOpen.CurveCollection](#) and [NXOpen.UF.UFCurve](#) classes in the NXOpen Reference Guide.

## ■ Lines

The [NXOpen.CurveCollection](#) class contains two functions for creating lines, as follows:

Function	Inputs and Creation Method
<code>CreateLine(p0 As Point3d, p1 As Point3d)</code>	Between two Point3d locations
<code>CreateLine(p0 As NXOpen.Point, p1 As NXOpen.Point)</code>	Between two points (NXOpen.Point objects)

The following fragment of code creates two points and two lines in your Work Part:

```
Dim p0 As New NXOpen.Point3d(1,2,3)
Dim p1 As New NXOpen.Point3d(4,7,5)
Dim line1 As NXOpen.Line = workPart.Curves.CreateLine(p0, p1)

Dim pt0 As NXOpen.Point = workPart.Points.CreatePoint(p0)
Dim pt1 As NXOpen.Point = workPart.Points.CreatePoint(p1)
Dim line2 As NXOpen.Line = workPart.Curves.CreateLine(pt0, pt1)
line2.SetVisibility(SmartObject.VisibilityOption.Visible)
```

The code that creates `line1` above is what you will get if you record the creation of a line using Insert → Curve → Basic Curves.

Note that we had to set the visibility of `line2` because lines created via this method are invisible by default.

There are other ways to create lines, too. There is [NXOpen.UF.UFCurve.CreateLine](#), and the [NXOpen.LineCollection](#) class also has some functions for creating lines along the axes of various types of surfaces of revolution.

The geometric properties of lines are:

Data Type	Property	Access	Description
Point3d	StartPoint	get	Start point (point where t = 0).
Point3d	EndPoint	get	End point (point where t = 1).

The `StartPoint` and `EndPoint` properties cannot be set directly, but the [NXOpen.Line](#) class provides `SetStartPoint`, `SetEndPoint`, and `SetEndPoints` functions that let you modify a line:

```
Dim newPoint = New Point3d(6,7,9)
myLine.SetEndPoint(newPoint)
```

There is also a [Guide.CreateLine](#) function, which makes it even easier to create a line.

## ■ Associative Line Features

In the code in the previous section, neither `line1` nor `line2` is associative. If you want to create associative lines, you should use the [AssociativeLineBuilder](#) class, instead. Code that uses this class will be produced if you record the

creation of a line using Insert → Curve → Line. The recorded code may be rather long, but its essential parts are as follows:

```
' Create an AssociativeLineBuilder
Dim lineNothing As NXOpen.Features.AssociativeLine = Nothing
Dim builder As NXOpen.Features.AssociativeLineBuilder
builder = workPart.BaseFeatures.CreateAssociativeLineBuilder(lineNothing)
builder.Associative = True

' Define the start point
Dim p0 As New NXOpen.Point3d(1,2,3)
Dim pt0 As NXOpen.Point = workPart.Points.CreatePoint(p0)
builder.StartPointOptions = NXOpen.Features.AssociativeLineBuilder.StartOption.Point
builder.StartPoint.Value = pt0

' Define the end point
Dim p1 As New NXOpen.Point3d(4,7,5)
Dim pt1 As NXOpen.Point = workPart.Points.CreatePoint(p1)
builder.EndPointOptions = NXOpen.Features.AssociativeLineBuilder.EndOption.Point
builder.EndPoint.Value = pt1

' Create an associative line feature
Dim result As NXOpen.NXObject = builder.Commit
builder.Destroy
```

The result object created by this code is actually an Associative Line feature, rather than a line. This has advantages, sometimes — the feature appears in the Part Navigator and some forms of editing are easier. To obtain an old-fashioned line from an AssociativeLine feature, add the following two lines to the code above:

```
Dim assocLine As NXOpen.Features.AssociativeLine = result
Dim myLine As NXOpen.Line = assocLine.GetEntities(0)
```

## ■ Arcs and Circles

The simplest functions for creating circular arcs can again be found in the `NXOpen.CurveCollection` class. There are three functions, as follows:

Function	Inputs and Creation Method
<pre>Public Function CreateArc(     startPoint As Point3d,     pointOn As Point3d,     endPoint As Point3d,     alternateSolution As Boolean,     ByRef flipped As Boolean)</pre>	Through three points
<pre>Public Function CreateArc(     center As Point3d,     xDirection As Vector3d,     yDirection As Vector3d,     radius As Double,     startAngle As Double,     endAngle As Double)</pre>	From center, radius, angles, axis vectors. The arc lies in the plane containing the two given vectors. The center point is expressed using Absolute Coordinates, and the angles are in radians, measured in a counterclockwise direction from the xDirection vector.
Function	Inputs and Creation Method
<pre>Public Function CreateArc(     center As Point3d,     matrix As NXMatrix,     radius As Double,</pre>	From center point, radius, angles, orientation matrix. The arc lies in the XY-plane of the matrix. The center point is expressed using Absolute Coordinates, and

```
startAngle As Double,  
endAngle As Double)
```

the angles are in radians, measured in a counterclockwise direction from the x-axis of the matrix.

There are no specific functions for creating complete circles; we simply set `endAngle = startAngle + 2π`.

Here is a simple program that uses lines and arcs to create a linkage bar lying in the YZ plane:

```
Dim curves As NXOpen.CurveCollection = workPart.Curves  
  
Dim length As Double = 8  
Dim width As Double = 4  
Dim half As Double = width/2  
Dim holeDiam As Double = half  
Dim pi As Double = System.Math.PI  
Dim twopi As Double = 2*pi  
  
Dim p1, p2, p3, q1, q2, q3 As NXOpen.Point3d  
  
p1 = New Point3d(0, -half, 0) : q1 = New Point3d(0, -half, length)  
p2 = New Point3d(0, 0, 0) : q2 = New Point3d(0, 0, length)  
p3 = New Point3d(0, half, 0) : q3 = New Point3d(0, half, length)  
  
' Left and right sides  
curves.CreateLine(p1, q1)  
curves.CreateLine(p3, q3)  
  
Dim axisX = New Vector3d(0,1,0) ' Horizontal  
Dim axisY = New Vector3d(0,0,1) ' Vertical  
  
' Top and bottom arcs  
curves.CreateArc(q2, axisX, axisY, half, 0, pi)  
curves.CreateArc(p2, axisX, axisY, half, pi, twopi)  
  
' Top and bottom holes  
curves.CreateArc(q2, axisX, axisY, holeDiam/2, 0, twopi)  
curves.CreateArc(p2, axisX, axisY, holeDiam/2, 0, twopi)
```

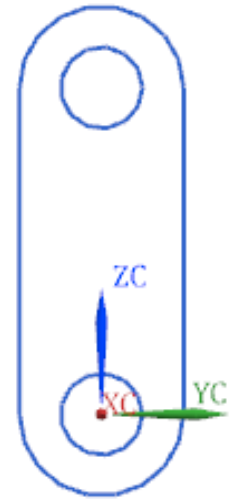

There are other ways to create arcs, too. For example, the `NXOpen.UF.UFCurve` class has functions `CreateArc`, `CreateArcThru3pts`, and `CreateFillet`. The `NXOpen.ArcCollection` class does not have any functions for creating arcs. Finally, there are two `Guide.CreateCircle` functions that are very easy to use.

The properties of arc objects are as follows:

Data Type	Property	Access	Description
Double	Radius	get	Radius of arc.
Point3d	Center	get	Center of arc (in absolute coordinates).
Double	StartAngle	get	Start angle (in radians).
Double	EndAngle	get	End angle (in radians).

None of these properties can be set directly, but the `NXOpen.Arc` class includes two `SetParameters` functions that let you modify an arc in any way you want.

## ■ Associative Arc Features

The code in the previous section creates plain ordinary arc objects that are not associative. These are perfectly adequate for many applications, and are easy to create, but there may be situations where you want to create an associative arc, instead. To do this, you should use the `AssociativeArcBuilder` class. Code that uses this class will be produced if you record the creation of an arc using `Insert`→`Curve`→`Arc`. The recorded code may be rather long, but the essential parts are as follows:

```
' Create an AssociativeArcBuilder
Dim arcNothing As NXOpen.Features.AssociativeArc = Nothing
Dim builder As NXOpen.Features.AssociativeArcBuilder
builder = workPart.BaseFeatures.CreateAssociativeArcBuilder(arcNothing)
builder.Associative = True

' Set the type of associative arc
builder.Type = NXOpen.Features.AssociativeArcBuilder.Types.ArcFromCenter

' Define the arc center point
Dim centerCoords As New Point3d(1.1, 2.2, 0)
Dim centerPoint As NXOpen.Point = workPart.Points.CreatePoint(centerCoords)
builder.CenterPoint.Value = centerPoint

' Define the arc radius
builder.EndPointOptions = NXOpen.Features.AssociativeArcBuilder.EndOption.Radius
builder.Radius.RightHandSide = "7.89"

' Define the angular limits (in degrees)
builder.Limits.StartLimit.LimitOption = GeometricUtilities.CurveExtendData.LimitOptions.Value
builder.Limits.EndLimit.LimitOption = GeometricUtilities.CurveExtendData.LimitOptions.Value
builder.Limits.StartLimit.Distance.RightHandSide = "22.2"
builder.Limits.EndLimit.Distance.RightHandSide = "55.5"

' Create an associative arc feature and get its arc
Dim myArcFeature As NXOpen.Features.AssociativeArc = builder.Commit
builder.Destroy
Dim myArc As NXOpen.Arc = myArcFeature.GetEntities()(0)
```

The last line of code gets an ordinary `NXOpen.Arc` object from the `AssociativeArc` feature, which may or may not be necessary, depending on your application.

An `AssociativeArcBuilder` object has a large number of properties — around 30 of them, in all. The best way to understand what they all mean is to look at the dialog for creating an arc in interactive NX. For example, we defined the start and end angles of the arc using two expressions that give the angular limits in degrees. If you edit the arc we created, you will see these expressions near the bottom of the edit dialog:

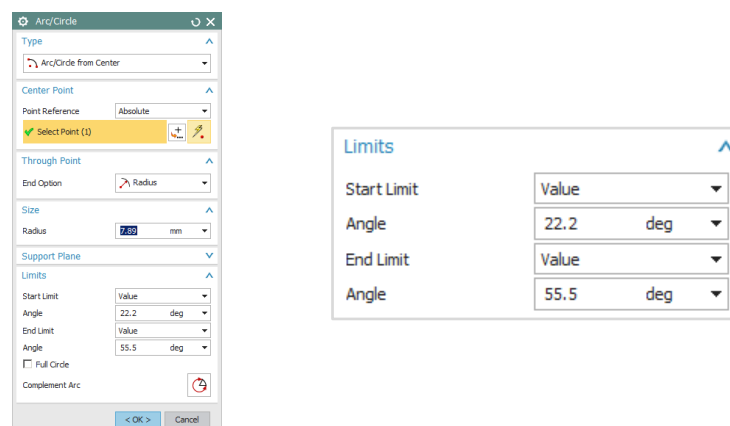

You can create a full 360 degree circle by setting the limiting angles to 0 and 360, of course. Alternatively, you can just set `builder.Limits.FullCircle = True`.

## ■ Conic Section Curves

Simple functions for creating conic section curves (ellipses, parabolas, hyperbolas) can be found in the `NXOpen.CurveCollection` class. For example, one of the functions for creating an ellipse is as follows:

Function	Inputs and Creation Method
<pre>public Ellipse CreateEllipse(     Point3d center,     double majorRadius,     double minorRadius,     double startAngle,     double endAngle,     double rotationAngle,     NXMatrix matrix)</pre>	<p>Creates an ellipse</p> <p>The ellipse lies in the XY plane defined by the given matrix.</p> <p>The center point is expressed using Absolute Coordinates, and the angles are in radians, measured relative to the given matrix's axes.</p>

To create an ellipse using this function, the code is as follows:

```
'Get the matrix of the current WCS  
Dim wcsMatrix As NXOpen.NXMatrix = workPart.WCS.CoordinateSystem.Orientation  
  
Dim pi As Double = System.Math.PI  
  
Dim center As New NXOpen.Point3d(0,0,0) ' Center point (absolute coordinates)  
Dim rX As Double = 2 ' Major Radius  
Dim rY As Double = 1 ' Minor radius  
Dim a0 As Double = 0 ' Start angle  
Dim a1 As Double = pi ' End angle  
Dim rot As Double = pi/6 ' Rotation angle  
  
workPart.Curves.CreateEllipse(center, rX, rY, a0, a1, rot, wcsMatrix)
```

This creates half of a full ellipse, lying in a plane parallel to the work plane, with its center at the absolute origin. The ellipse is rotated in its plane by an angle of 30 degrees ( $\pi/6$  radians).

The `NXOpen.Features.GeneralConicBuilder` class allows you to create conic section curves by different techniques, by specifying various combinations of point and tangency constraints.

The `NXOpen.UF.UFCurve` class also provides the `CreateConic`, and `EditConicData` functions.

## ■ Splines

The NX Open functions for handling splines use a fairly conventional NURBS representation that consists of:

- Poles — An array of  $n$  3D vectors representing poles (control vertices)
- Weights — An array of  $n$  weight values (which must be strictly positive)
- Knots — An array of  $n + k$  knot values:  $t[0], \dots, t[n + k - 1]$

The order and degree of the spline can be calculated from the sizes of these arrays, as follows:

- Let  $n$  = number of poles = `Poles.Length`
- Let  $npk = n + k$  = number of knots = `Knots.Length`

Then the order,  $k$ , is given by  $k = npk - n$ . Finally, as usual, the degree,  $m$ , is given by  $m = k - 1$ .

You may not be familiar with the “weight” values associated with the poles, since these are not very visible within interactive NX — you can see them in the Info function, but you can’t modify them. So, in this case, the NX Open API actually gives you more power than interactive NX. Generally, the equation of a spline curve is given by a rational function (the quotient of two polynomials). This is why spline curves are sometimes known as NURBS (Non-Uniform Rational B-Spline) curves. If the weights are all equal (and specifically if they are all equal to 1), then some cancellation occurs, and the equation becomes a polynomial.

The mathematical theory of splines is quite extensive (one of the best-known books on the subject is more than 600 pages long), so we can only scratch the surface here. For more information, please consult a text-book, or one of the many available on-line resources.

The simplest function for creating a spline is `NXOpen.UF.UFModl.CreateSpline`, because its inputs closely match the defining data outlined above. The code is as follows:

```
Dim n As Integer = 4 ' Number of poles
Dim k As Integer = 3 ' Order of curve (degree = k-1 = 2)

' 3D coordinates of poles
Dim p As Double(,) = { {1,0,0}, {3,1,0}, {5,1,0}, {6,0,0} }

' Weights
Dim w As Double() = {1, 1, 0.7, 1}

' Construct 4D poles
Dim poles4D(4*n-1) As Double
For i As Integer = 0 to n-1
    poles4D(4*i) = w(i) * p(i,0)
    poles4D(4*i + 1) = w(i) * p(i,1)
    poles4D(4*i + 2) = w(i) * p(i,2)
    poles4D(4*i + 3) = w(i)
Next

' Knots must be an array of length n + k
Dim knots As Double() = {0,0,0, 0.6, 1,1,1}

Dim splineTag As NXOpen.Tag
Dim knotFixup As Integer = 0
Dim poleFixup As Integer = 0

Dim ufs As NXOpen.UF.UFSession = NXOpen.UF.UFSession.GetUFSession
ufs.Modl.CreateSpline(n, k, knots, poles4D, splineTag, knotFixup, poleFixup)
```

Note how the 3D poles and the weights are combined into 4D elements of the form  $(wx, wy, wz, w)$ .

The code above is somewhat unusual because it uses weights that are not all equal, and therefore it creates a rational curve (rather than a polynomial one). In most cases, you would set all weights equal to one, so the `poles4D` array would simply be: `1,0,0,1, 3,1,0,1, 5,1,0,1, 6,0,0,1`.

To construct a curve of order  $k$  with  $n$  poles, you need  $n + k$  knots. So, in our case, we need 7 knots. Since the curve has order 3, the knot sequence should begin with 3 0's and end with 3 1's. That only leaves one knot value undecided, and the code above assigns it a value of 0.6.

The `CreateSpline` function returns two integers `knotFixup` and `poleFixup` that indicate whether or not any "fixup" of the data was performed inside NX. A typical fixup is a slight adjustment of knot values or poles that are very close together but not identical. In almost all cases, you will find that both fixup values are zero, indicating that no adjustments were required.

There are several other functions for creating and editing splines. The `NXOpen.UF.UFCurve` class provides a function `CreateSplineThruPts` that allows you to construct a spline that passes through given points, and also lets you specify slopes and curvatures at these points. Also, in `NXOpen.UF.UFModl`, there is a function called `CreateFittedSpline` that performs smoothing by creating a spline that approximates given points without necessarily passing through them exactly.

The NX.Spline class provides several properties and functions that you can use to get information about a spline curve, as follows:

Data Type	Function/Property	Access	Description
Boolean	Rational	get	If true, indicates that the spline is rational (not polynomial)
Boolean	Periodic	get	If true, indicates that the spline is periodic
Point4d[]	GetPoles	get	The 4D poles of the spline (wx, wy, wz, w)
Integer	PoleCount	get	The number of poles; equal to GetPoles.Length/4
Double[]	GetKnots	get	The knots of the spline
Integer	Order	get	The order of the curve (= degree + 1)

## ■ Studio Splines

The functions described in the previous section all create `NXOpen.Spline` objects. In some situations, you might want to create a Studio Spline feature, instead, because this feature will appear in the Part Navigator and some forms of editing are easier. You proceed in the standard way, by first creating a `StudioSplineBuilderEx` object, and then setting its properties. Many of the properties take the form of geometric constraints that control the shape of the curve. For example, you can specify points that the spline should pass through, tangent directions, curvatures, and so on. To make the coding more convenient, let's first write a small "helper" function that provides an easy way to add a "point" constraint to a `StudioSplineBuilderEx` object:

```
Private Shared Sub AddPoint(builder As Features.StudioSplineBuilderEx, coords As NXOpen.Point3d)
    Dim workPart As NXOpen.Part = NXOpen.Session.GetSession.Parts.Work
    Dim point As NXOpen.Point = workPart.Points.CreatePoint(coords)
    Dim geomCon As NXOpen.Features.GeometricConstraintData
    geomCon = builder.ConstraintManager.CreateGeometricConstraintData
    geomCon.Point = point
    builder.ConstraintManager.Append(geomCon)
End Sub
```

Using this helper function, here's how we construct a Studio Spline feature:

```
' Create the builder
Dim builder As NXOpen.Features.StudioSplineBuilderEx
builder = workPart.Features.CreateStudioSplineBuilderEx(Nothing)

' Set a few properties
builder.Type = NXOpen.Features.StudioSplineBuilderEx.Types.ByPoles
builder.IsSingleSegment = True
builder.IsAssociative = True

' Add some point constraints
Dim pt1 As New NXOpen.Point3d(0, 7, 1) : AddPoint(builder, pt1)
Dim pt2 As New NXOpen.Point3d(2, 7, 1) : AddPoint(builder, pt2)
Dim pt3 As New NXOpen.Point3d(5, 9, 0) : AddPoint(builder, pt3)

' Create the Studio Spline Feature
Dim splineFeature As NXOpen.Features.StudioSpline = builder.Commit

' Get the spline curve (if necessary)
Dim spline As NXOpen.Spline = builder.Curve

builder.Destroy
```

Notice that we have set `IsAssociative = True`. If we had set this property to `False`, instead, then `splineFeature` would be `Nothing`. However, an `NXOpen.Spline` curve would still be created, which we could then use in subsequent operations.

## Sketches

A sketch is a collection of curves that are controlled by a system of geometric and dimensional constraints. The system of constraints is solved to give the sketch curves the desired size and shape.

As an example, we will create a sketch that forms a “bridge” between two points. We will construct a circular arc, and constrain it to have a given arclength and to pass through the two given points  $p_0 = (2,0,0)$  and  $p_1 = (0,0,0)$ .



We begin by creating a datum plane and a datum axis to control the orientation of our sketch:

```
Dim origin As New NXOpen.Point3d(0,0,0)
Dim axisX As New NXOpen.Point3d(1,0,0)
Dim wcsMatrix As NXOpen.Matrix3x3 = workPart.WCS.CoordinateSystem.Orientation.Element
Dim sketchPlane As NXOpen.DatumPlane = workPart.Datums.CreateFixedDatumPlane(origin, wcsMatrix)
Dim horizAxis As NXOpen.DatumAxis = workPart.Datums.CreateFixedDatumAxis(origin, axisX)
```

Next, we create an empty sketch (that does not yet contain any curves), using the familiar builder technique:

```
Dim sketchBuilder As NXOpen.SketchInPlaceBuilder
sketchBuilder = workPart.Sketches.CreateNewSketchInPlaceBuilder(Nothing)

sketchBuilder.PlaneOrFace.Value = sketchPlane
sketchBuilder.Axis.Value = horizAxis
sketchBuilder.SketchOrigin = workPart.Points.CreatePoint(origin)
sketchBuilder.PlaneOption = NXOpen.Sketch.PlaneOption.Inferred

Dim bridgeSketch As NXOpen.Sketch = sketchBuilder.Commit
sketchBuilder.Destroy

bridgeSketch.Activate(NXOpen.Sketch.ViewReorient.False)
```

The last line of code activates the sketch, allowing us to add curves and constraints to it. Next, we create an arc through three points, and add it to our sketch:

```
Dim p0 As New NXOpen.Point3d(2,0,0) ' Start point
Dim p1 As New NXOpen.Point3d(0,0,0) ' End point
Dim pm As New NXOpen.Point3d(1,1,0) ' Interior point
Dim gotFlipped As Boolean = False
Dim bridge As NXOpen.Arc = workPart.Curves.CreateArc(p0, pm, p1, False, gotFlipped)

theSession.ActiveSketch.AddGeometry(bridge,
NXOpen.Sketch.InferConstraintsOption.InferNoConstraints)
```

In this construction, the middle point  $pm$  is somewhat arbitrary; after solving, the arc will no longer pass through this point.



The next step is to create some constraints that make the start and end points of the arc coincident with the two given points `p0` and `p1`. The code for constraining the start point is as follows:

```
Dim arcPt0 As New NXOpen.Sketch.ConstraintGeometry
arcPt0.Geometry = bridge
arcPt0.PointType = NXOpen.Sketch.ConstraintPointType.StartVertex
arcPt0.SplineDefiningPointIndex = 0

Dim pt0 As New NXOpen.Sketch.ConstraintGeometry
pt0.Geometry = workPart.Points.CreatePoint(p0)
pt0.PointType = NXOpen.Sketch.ConstraintPointType.None
pt0.SplineDefiningPointIndex = 0

theSession.ActiveSketch.CreateCoincidentConstraint(arcPt0, pt0)
```

As you can see, we do not use the point `p0` and the arc end-point directly — we first construct `ConstraintGeometry` objects that are then used as input to the `CreateCoincidentConstraint` function. The code for constraining the arc's end-point is analogous:

```
Dim arcPt1 As New NXOpen.Sketch.ConstraintGeometry
arcPt1.Geometry = bridge
arcPt1.PointType = NXOpen.Sketch.ConstraintPointType.EndVertex
arcPt1.SplineDefiningPointIndex = 0

Dim pt1 As New NXOpen.Sketch.ConstraintGeometry
pt1.Geometry = workPart.Points.CreatePoint(p1)
pt1.PointType = NXOpen.Sketch.ConstraintPointType.None
pt1.SplineDefiningPointIndex = 0

theSession.ActiveSketch.CreateCoincidentConstraint(arcPt1, pt1)
```

The “coincidence” constraint we have used here is the most common type, but the `Sketch` class provides functions for creating many other types. For example, parallel, perpendicular and concentric constraints are supported, as in interactive NX. Next, we create a “perimeter” dimension to control the length of the arc:

```
Dim length As NXOpen.Expression = workPart.Expressions.CreateExpression("Number", "length = 2.5")
Dim perimeter As NXOpen.Curve() = {bridge}
theSession.ActiveSketch.CreatePerimeterDimension(perimeter, origin, length)
```

Typically, the perimeter of a sketch will consist of an array of curves, of course, but here we have only one. Again, the `Sketch` class provides functions for creating various other types of dimensional constraints (linear, angular, diameter, and so on). Finally, we “update” the sketch, and deactivate it.

```
theSession.ActiveSketch.LocalUpdate
theSession.ActiveSketch.Deactivate(NXOpen.Sketch.ViewReorient.False,
NXOpen.Sketch.UpdateLevel.Model)
```

When we call the `LocalUpdate` function, the sketch is solved, but the children of the sketch (if any) are not updated. After executing the code, the user can adjust the value of the “length” expression to modify the shape of the curve. The picture below shows some sample curves with lengths 2.3, 2.4, and 2.5:



---

## Chapter 8: Simple Solids and Sheets

---

This chapter briefly outlines a few of the NX Open functions that are available for creating simple solid and sheet bodies. Typically, these functions create features, so you sometimes have to do a bit of extra work to get the constituent bodies, as explained later in [chapter 10](#).

### ■ Creating Primitive Solids

The `NXOpen.Features` class provides a variety of functions for creating simple solid primitive features (blocks, cylinders, cones, spheres, etc.). As an example, let's consider the following code that builds a sphere feature:

```
Dim builder As NXOpen.Features.SphereBuilder
builder = workPart.Features.CreateSphereBuilder(Nothing)

' Specify the sphere definition type (center and diameter)
builder.Type = Features.SphereBuilder.Types.CenterPointAndDiameter

' Define the sphere center
Dim center As New NXOpen.Point3d(3,5,6)
Dim centerPoint As NXOpen.Point = workPart.Points.CreatePoint(center)
builder.CenterPoint = centerPoint

' Define the sphere diameter
Dim diamString As String = "1.5"
builder.Diameter.RightHandSide = diamString

' Define the boolean option (create, unite, etc.)
builder.BooleanOption.Type = NXOpen.GeometricUtilities.BooleanOperation.BooleanType.Create

' Commit to create the feature
Dim sphereObject As NXOpen.Features.Sphere = builder.CommitFeature

' Destroy the builder to free memory
builder.Destroy
```

So, we see that the creation process follows the “builder” pattern that we explained in [chapter 5](#). The general approach is to

- Create a “builder” object
- Modify its properties as desired
- “Commit” the builder to create a new feature

Functions to create various types of “builder” objects are methods of a `FeatureCollection` object, and we can get one of these from the `workPart.Features` property.

You can create Block, Cylinder and Cone features using similar techniques. As you would expect, the relevant builder objects are `BlockFeatureBuilder`, `CylinderBuilder`, and `ConeBuilder`. Of these, the `ConeBuilder` object is the most complex, because it has several different values for its “Type” property, and several dimensional parameters (diameters, height, angle) that are interdependent. The set of relevant parameters depends on the value of the `Type` property. For example, if you set `Type = DiametersAndHeight`, then the only relevant parameters are `BaseDiameter`, `TopDiameter`, and `Height`. You can assign a value to the `HalfAngle` parameter, too, but this setting will simply be ignored, as the following code illustrates:

```
Dim builder = workPart.Features.CreateConeBuilder(Nothing)
' Specify the cone definition type (diameters and height)
builder.Type = NXOpen.Features.ConeBuilder.Types.DiametersAndHeight
' Define the diameters and height (these settings are relevant)
builder.BaseDiameter.RightHandSide = "3"
builder.TopDiameter.RightHandSide = "1.0"
builder.Height.RightHandSide = "4"
' Try to define HalfAngle (no error; this is just ignored)
builder.HalfAngle.RightHandSide = "1"
```

It's usually fairly obvious which parameters are used with each setting of the `Type` property. If you're in doubt, you can experiment with the Cone dialog in interactive NX. As you change the Type setting, the relevant set of parameters will be shown in the lower portion of the dialog.

The examples in this document often use spheres and cylinders to illustrate some point, so we provide simple [Guide.CreateSphere](#) and [Guide.CreateCylinder](#) functions to make these easy to create.

## ■ Sections

Before we discuss Extruded and Revolved features, we need to explain the concept of a “section”. When you are selecting curves for use in Extrude, or Revolve, or many other NX functions, a menu appears in the top border bar showing you the available “Selection Intent” rules.

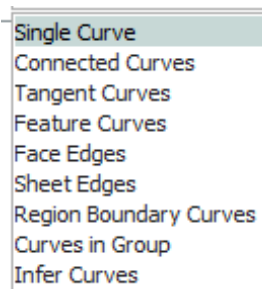

This menu allows you to define a collection of curves that is dynamic in the sense that its members are determined on-the-fly based on the rule you specify. So, for example, if you select a face F and choose the “Face Edges” rule, your collection will contain all the edges of the face F. If the face F happens to change, as the result of model editing, then your collection will **still** consist of all the edges of F, whatever these might now be. The collection of curves is “smart” in the sense that it responds to changes in the model; in fact, as we will see, a collection defined in this way is sometimes referred to as a “Smart Collector”.

In NX Open, there is a corresponding [SelectionIntentRule](#) class, which has numerous derived classes, including

- CurveDumbRule
- CurveChainRule
- CurveFeatureChainRule
- CurveFeatureRule
- CurveFeatureTangentRule
- CurveGroupRule
- CurveTangentRule

The simplest type of these is the [CurveDumbRule](#), which just collects a specific list of curves, as its name suggests. In an NX Open program, this is often appropriate, since the collection logic will reside in your code, rather than in NX data structures.

To create a selection intent rule of type [CurveDumbRule](#) from a given array of curves, the code is just:

```
Dim dumbrule As CurveDumbRule = workPart.ScRuleFactory.CreateRuleCurveDumb(curveArray)
```

The “Sc” in `ScRuleFactory` stands for “Smart Collector”. Then, once we have this rule, we can use it to add curves to a section. So, if we have a single curve named `arc`, the code to create a section is:

```
' Create a selection intent rule specifying a single arc
Dim dumbRule As NXOpen.CurveDumbRule = workPart.ScRuleFactory.CreateRuleBaseCurveDumb({arc})
Dim rules As NXOpen.SelectionIntentRule() = {dumbRule}

' Create a section
Dim mySection As NXOpen.Section = workPart.Sections.CreateSection(0.0095, 0.01, 0.5)

Dim help As New NXOpen.Point3d(0,0,0)
Dim nullObj As NXOpen.NXObject = Nothing

' Use the rule to add the arc to the section
Dim noChain As Boolean = False
mySection.AddToSection(rules, arc, nullObj, nullObj, help, NXOpen.Section.Mode.Create, noChain)
```

If we want a rectangular section consisting of four lines, then we add these one at a time, as follows:

```
' Create four lines
Dim c1 = workPart.Curves.CreateLine(New Point3d(1,0,0), New Point3d(3,0,0))
Dim c2 = workPart.Curves.CreateLine(New Point3d(3,0,0), New Point3d(3,1,0))
Dim c3 = workPart.Curves.CreateLine(New Point3d(3,1,0), New Point3d(1,1,0))
Dim c4 = workPart.Curves.CreateLine(New Point3d(1,1,0), New Point3d(1,0,0))

Dim ctol = 0.0095 ' Chaining tolerance
Dim dtol = 0.01 ' Distance tolerance
Dim atol = 0.5 ' Angle tolerance

' Create a rectangular section
Dim rect As NXOpen.Section = workPart.Sections.CreateSection(ctol, dtol, atol)

Dim helpPoint As New NXOpen.Point3d(0,0,0)
Dim nullObj As NXOpen.NXObject = Nothing
Dim noChain As Boolean = False
Dim createMode As NXOpen.Section.Mode = Section.Mode.Create

' Create rules to add the four lines to the section
Dim r1 As NXOpen.CurveDumbRule = workPart.ScRuleFactory.CreateRuleBaseCurveDumb({c1})
Dim r2 As NXOpen.CurveDumbRule = workPart.ScRuleFactory.CreateRuleBaseCurveDumb({c2})
Dim r3 As NXOpen.CurveDumbRule = workPart.ScRuleFactory.CreateRuleBaseCurveDumb({c3})
Dim r4 As NXOpen.CurveDumbRule = workPart.ScRuleFactory.CreateRuleBaseCurveDumb({c4})

rect.AddToSection({r1}, c1, nullObj, nullObj, helpPoint, createMode, noChain)
rect.AddToSection({r2}, c2, nullObj, nullObj, helpPoint, createMode, noChain)
rect.AddToSection({r3}, c3, nullObj, nullObj, helpPoint, createMode, noChain)
rect.AddToSection({r4}, c4, nullObj, nullObj, helpPoint, createMode, noChain)
```

Using other types of rules is quite similar. For example, if we want a section that gathers together all the edges of a face `myFace`, we write:

```
Dim faceRule As NXOpen.EdgeBoundaryRule = workPart.ScRuleFactory.CreateRuleEdgeBoundary({myFace})
mySection.AddToSection({faceRule}, myFace, nullObj, nullObj, help, NXOpen.Section.Mode.Create, False)
```

We can use the section to create an Extrude feature, a Revolve feature, or numerous other types.

## ■ Extruded Bodies

Once we have created a section, creating an Extrude feature is quite straightforward. So, suppose we have created a section called `mySection`, as in the code above. To extrude this section in the z-direction we write:

```
' Create an ExtrudeBuilder
Dim builder = workPart.Features.CreateExtrudeBuilder(Nothing)

' Define the section for the Extrude
builder.Section = mySection

' Define the direction for the Extrude
Dim origin As New NXOpen.Point3d(0,0,0)
Dim axisZ As New NXOpen.Vector3d(0,0,1)
Dim updateOption = SmartObject.UpdateOption.DontUpdate
builder.Direction = workPart.Directions.CreateDirection(origin, axisZ, updateOption)

' Define the extents of the Extrude
builder.Limits.StartExtend.Value.RightHandSide = "-0.25"
builder.Limits.EndExtend.Value.RightHandSide = "0.5"

Dim extrudeFeature As NXOpen.Features.Extrude = builder.CommitFeature

builder.Destroy
```

If your section consists of an open string of curves that do not enclose a region, then the result will be a sheet body, of course. On the other hand, when you extrude a closed section, you can decide whether you want a sheet body or a solid body as the result. The draft angle(s) of the extruded body can be controlled by using the `extrudeBuilder.Draft` property, and thin-walled extrusions can be created using the `extrudeBuilder.Offset` property. So, to create a sheet body with a 15 degree draft angle, we write:

```
builder.FeatureOptions.BodyType = GeometricUtilities.FeatureOptions.BodyStyle.Sheet
builder.Draft.DraftOption = GeometricUtilities.SimpleDraft.SimpleDraftType.SimpleFromProfile
builder.Draft.FrontDraftAngle.RightHandSide = "15"
```

Using the rectangular section named `rect` that we defined above, the result is:

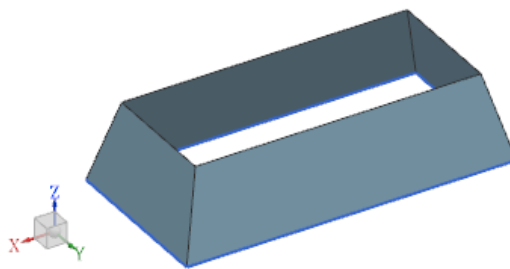

Another extrude example can be found in `[NX]\UGOPEN\SampleNXOpenApplications\.NET\QuickExtrude`.

## ■ Revolved Bodies

Creating Revolved features is quite similar to creating Extruded ones. Again, most of the work is in the creation of the section that we revolve. So, suppose we have already created the `rect` section as shown above. To revolve this section around the y-axis, the code is:

```
' Create the Revolve builder
Dim builder = workPart.Features.CreateRevolveBuilder(Nothing)

' Define the section for the Revolve (see above for details)
builder.Section = rect

' Define the axis to revolve around (the y-axis of the Absolute Coordinate System)
Dim axisPoint3d As New NXOpen.Point3d(0, 0, 0)
Dim axisVector As New NXOpen.Vector3d(0, 1, 0)
Dim updateOption = SmartObject.UpdateOption.WithinModeling

' Define a direction to pass the revolve point and axis to the builder
Dim direction = workPart.Directions.CreateDirection(axisPoint3d, axisVector, updateOption)
Dim axisPoint As NXOpen.Point = workPart.Points.CreatePoint(axisPoint3d)
builder.Axis = workPart.Axes.CreateAxis(axisPoint, direction, updateOption)

' Define the extents of the Revolve (in degrees)
builder.Limits.StartExtend.Value.RightHandSide = "0"
builder.Limits.EndExtend.Value.RightHandSide = "90"

' Commit and then destroy the builder
Dim revolveFeature As NXOpen.Features.Revolve = builder.CommitFeature
builder.Destroy
```

This produces the result shown below

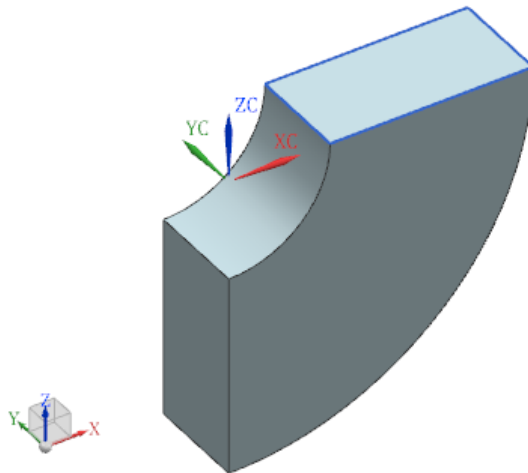

# Chapter 9: Object Properties & Methods

The objects in the `NXOpen` namespace have a rich set of properties that let us get information about the objects and (in some cases) modify them. The complete properties of each object are documented in the NX Open Reference Guide, so the overview provided here is just to help you understand the basic concepts.

As we mentioned in chapter 4, objects inherit properties from the parent classes from which they are derived, in addition to having properties of their own. So, since `NXOpen.Arc` inherits from `NXOpen.Conic`, which in turn inherits from `NXOpen.Curve`, an `NXOpen.Arc` object has all the properties of an `NXOpen.Conic` object and all the properties of an `NXOpen.Curve` object, in addition to specific properties of its own.

In the NX Open Reference Guide, you can control whether or not inherited members are displayed by clicking in the check-box circled in red below:

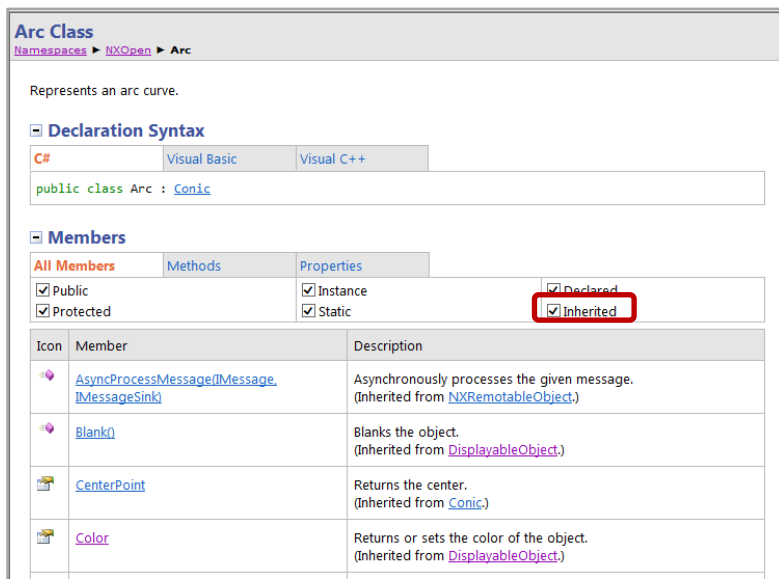

As you can see, there are two members that `NXOpen.Arc` inherits from `NXOpen.DisplayableObject`, one that it inherits from `NXOpen.Conic`, and one that it inherits from `NXOpen.DisplayableObject`. All four of these will be hidden if you uncheck the “inherited” box.

## NXObject Properties

Most objects in the NX Open object hierarchy inherit from `NXOpen.NXObject`, so its properties are very important because they trickle down to all the lower-level objects. The properties can be divided into several categories, as outlined below:

### Type and Subtype Properties

Each NX Open object has a Type property and a Subtype property, which you will often use to make decisions about how to process the object. Some objects such as solid geometry objects have an additional `SolidBodyType` property. These properties are read-only, of course — you cannot change the type of an object.

Property	Query Method	Description
Type	<code>NXOpen.UF.UFObj.AskTypeAndSubtype</code>	The object's type
Subtype	<code>NXOpen.UF.UFObj.AskTypeAndSubtype</code>	The object's subtype
SolidBodyType		Optional detail type used by certain types of objects such as solid geometry objects.

Suppose the user has selected an object, for example. You might want to test whether this object is an ellipse before processing it.

The code to do this would be as follows:

```
' Get the UFSession
Dim ufs As NXOpen.UF.UFSession = NXOpen.UF.UFSession.GetUFSession

Dim thing As NX.NXObject = ...
Dim myType As Integer
Dim mySubType As Integer
ufs.Obj.AskTypeAndSubtype(thing.Tag, myType, mySubType)
If myType = NXOpen.UF.UFConstants.UF_conic_type And
    mySubType = NXOpen.UF.UFConstants.UF_conic_ellipse_subtype Then
    'Do something
End If
```

You can reduce the typing by putting `Imports NXOpen.UF.UFConstants` at the top of your file. In some cases, it might be more convenient to test the type of an object using the standard Visual Basic `TypeOf` function. For example, the code above could be written as:

```
Dim thing As NX.NXObject = ...
If TypeOf thing Is NXOpen.Ellipse
    'Do something
End If
```

## Display Properties

Many of the objects that NX users deal with are of type `NXOpen.DisplayableObject` (a subtype derived from `NXOpen.NXObject`). These objects have the following properties:

Data Type	Property	Access	Description
Integer	Layer	get, set	The layer on which the object resides
Boolean	IsBlanked	get	If true, indicates that the object is blanked (hidden)
Integer	Color	get, set	The color of the object as an index to the NX color palette
ObjectFont	LineFont	get, set	The line font used to draw the object (solid, dashed, etc.)
ObjectWidth	LineWidth	get, set	The line width used to draw the object
Point3d	NameLocation	get	The location of the object's name

Note that the `Color` attribute is a color index into the color palette for the part. The `NXOpen.UF.UFDisp` class contains several functions for working with NX color indices. For example, `NXOpen.UF.UFDisp.AskColor` gets the RGB values associated with a given color index, and `NXOpen.UF.UFDisp.AskClosestColor` does the reverse.

## Attribute Properties

For technical reasons, attributes cannot be implemented as “real” properties, so they are accessed via old-fashioned “Get” and “Set” methods on the `NXOpen.NXObject` class. All NX objects that can contain attributes



inherit from `NXObject`. A few of the available methods are listed below, and the complete set is covered in the documentation for the `NXOpen.NXObject` class in the NX Open Reference Guide:

<b>NXOpen.NXObject Method</b>	<b>Description</b>
<code>DeleteUserAttributes(Type As AttributeType, Title As String, DeleteArray As Boolean, Option As UpdateOption)</code>	Deletes the first attribute encountered with the given Type and Title. Can perform an update if desired. If attribute is an attribute array, can optionally delete the entire array.
<code>DeleteUserAttributes(Type As AttributeType, Option As Update.Option)</code>	Deletes the attributes encountered with the given Type. Can perform an update if desired.
<code>GetXxxUserAttribute(Title As String, Index As Integer)</code>	Gets the value of an attribute with the given Title and array Index (if the attribute is an array attribute). Xxx can be Boolean, Integer, Real, String, or Time.
<code>GetUserAttribute(Title As String, Index As Integer)</code>	Gets an AttributeInformation structure of the first attribute encountered on the object with a given Title and array Index (if attribute is an array attribute).
<code>GetUserAttributes()</code>	Gets an array of AttributeInformation structures of all the attributes that have been set on the object.
<code>HasUserAttribute(Title As String, Type As AttributeType, Index As Integer)</code>	Checks if the object has an attribute with the given Title, Type, and Index.
<code>Name</code>	The name of the object (aka “custom name”, sometimes)
<code>SetXxxUserAttribute(Title As String, Index As Integer, Value As Xxx, Option As Update.Option)</code>	Creates and/or sets the value of an attribute of type Xxx, where Xxx can be Boolean or Time. The attribute is identified by the string Title and array Index (if attribute is an array attribute). Can perform an update if desired.
<code>SetUserAttribute(Title As String, Integer, Value As Double, Option As Update.Option)</code>	Creates or modifies a real attribute. Arrays can be extended only one element at a time. Can perform an update if desired.
<code>SetUserAttribute(Title As String, Index As Integer, Value As Integer, Option As Update.Option)</code>	Creates or modifies an integer attribute. Arrays can be extended only one element at a time. Can perform an update if desired.
<code>SetUserAttribute(Title As String, Integer, Value As String, Option As Update.Option)</code>	Creates or modifies a string attribute. Arrays can be extended only one element at a time. Can perform an update if desired.

## ■ Curve and Edge Properties

In this section, we describe techniques for getting information about curves and edges. Specifically, we discuss how we can obtain position and tangent information, shape parameters like radius, and topological properties.

### Evaluators

Some of the most useful methods when working with curves or edges are the so-called “evaluator” functions. At a given location on a curve (defined by a parameter value *t*), we can ask for a variety of different values, such as the position of the point, or the tangent or curvature of the curve. The evaluator functions are provided by the `NXOpen.UF.UFEval` class. The most important functions are `Evaluate` and `EvaluateUnitVectors`

<b>Function</b>	<b>Values calculated</b>
<code>Evaluate</code>	Position and derivatives at given parameter value
<code>EvaluateUnitVectors</code>	Position, tangent, normal, binormal at given parameter value

The following code uses the `Evaluate` function to compute a position and tangent at a location along `myCurve`, which is assumed to be of type `NXOpen.Curve` or `NXOpen.Edge`

```

' Get the UFSession
Dim ufs As NXOpen.UF.UFSession = NXOpen.UF.UFSession.GetUFSession

' Get the tag of our curve
Dim curveTag As NXOpen.Tag = myCurve.Tag

' Create an evaluation structure
Dim eStruct As System.IntPtr
ufs.Eval.Initialize2(curveTag, eStruct)

' Compute point and first derivative at t = 0.5
Dim t As Double = 0.5
Dim numDerivs = 1
Dim coords As Double() = { 0, 0, 0 }
Dim derivs As Double() = { 0, 0, 0 }
ufs.Eval.Evaluate(eStruct, numDerivs, t, coords, derivs)
Dim curvePoint As New NXOpen.Point3d(coords(0), coords(1), coords(2))
Dim curveTangent As New NXOpen.Vector3d(derivs(0), derivs(1), derivs(2))

' Free the evaluation structure
ufs.Eval.Free(eStruct)

```

In other software systems, a common approach is to “normalize” the parameter value (t) that is passed to these sorts of evaluator functions, so that it lies in the range  $0 \leq t \leq 1$ . With this approach, the parameter value  $t = 0.5$  used in the code above would correspond to the parametric mid-point of the curve. In NX Open, this normalization process is not used, so the parameter values used are the original “native” parameters of the curve. So, in the example above, if `myCurve` was a circular arc, the parameter value  $t = 0.5$  would be the point at an angle of 0.5 radians.

If you want to use normalized parameter values, you can construct these yourself. The following code shows you how to compute a point that is 25% of the way along a given curve or edge denoted by `myCurve`:

```

' Get the parameter limits of the curve
Dim limits As Double()
ufs.Eval.AskLimits(eStruct, limits)

' Normalized parameter value is u = 0.25
Dim u As Double = 0.25

' Compute non-normalized parameter value, t
Dim t = (1-u)*limits(0) + u*limits(1)

' Compute point at t value
Dim coords As Double() = { 0, 0, 0 }
Dim derivs As Double() = { 0, 0, 0 }
ufs.Eval.Evaluate(eStruct, 0, t, coords, derivs)
Dim curvePoint As New NXOpen.Point3d(coords(0), coords(1), coords(2))

```

As we have seen above, the evaluator functions use an “evaluation structure” that is returned by an `Initialize2` function, rather than directly using the curve or edge itself. Then, after you have finished using this structure, you should call the `Free` function to release the memory it has been using. In between the `Initialize` and `Free` steps, you can use an evaluation structure as many times as you like. The code below shows a common technique for creating a sequence of points along a curve; as you can see, we initialize the evaluation structure once, use it 101 times, and then free it.

The example uses a spline curve, so we can safely assume that the parameter limits are 0 and 1:

```
' Create an evaluation structure for the spline
Dim estruct As System.IntPtr
ufs.Eval.Initialize2(splineTag, estruct)

' Prepare for stepping along the spline
Dim numDerivs = 1
Dim coords As Double() = {0, 0, 0}
Dim derivs As Double() = {0, 0, 0}

' Step along the spline, creating 101 points
For t As Double = 0 To 1 Step 0.01
    ufs.Eval.Evaluate(estruct, numDerivs, t, coords, derivs)
    Dim curvePosition As New NXOpen.Point3d(coords(0), coords(1), coords(2))
    workPart.Points.CreatePoint(curvePosition)
Next

' Free the evaluation structure
ufs.Eval.Free(estruct)
```

There is another function `NXOpen.UF.Modl.EvaluateCurve` that also allows you to calculate a point at a given parameter value. It is slightly simpler to use, but it only works with curves, not with edges.

## Edge Topology Properties

The main difference between an edge and a curve, of course, is that an edge is part of a body, whereas a curve is not. Because of this, an edge has “topological” properties that a curve does not have, which describe how the edge is connected to other items (faces, edges, vertices) within the body. Basic topology enquiries are quite simple: if `myEdge` is of type `NXOpen.Edge`, then you can use the `myEdge.GetFaces` function to find out which faces it belongs to, and the `myEdge.GetBody` function to find out which body it belongs to.

## Edge Geometry Properties

The `NXOpen.UF.EF.Eval` class has functions that return geometric properties of various types of edges. Specifically, there are functions named `AskLine`, `AskArc`, `AskSpline`, and so on. For example, the following code gets the center and radius of a circular edge, `myArcEdge`

```
' Get the tag of our edge
Dim edgeTag As NXOpen.Tag = myArcEdge.Tag

' Get an evaluation structure
Dim estruct As System.IntPtr
ufs.Eval.Initialize2(edgeTag, estruct)

' Get an arc evaluation structure
Dim evalArc As NXOpen.UF.EF.Eval.Arc
ufs.Eval.AskArc(estruct, evalArc)

' Get the edge's center and radius
Dim centerCoords As Double() = evalArc.center
Dim radius As Double = evalArc.radius

' Free the evaluation structure
ufs.Eval.Free(estruct)
```

## ■ Face Properties

Like edges, faces have evaluator functions, topological properties, and geometric properties.

### Evaluators

As with curves, we can call an “evaluator” function to calculate certain values at a given point on a surface (or a face). So, as you might expect, we can get the location of the point, the surface normal at the point, and so on. To indicate which point we’re interested in, we have to give two parameter values, traditionally denoted by *u* and *v*. The following code illustrates the approach:

```
Get the UFSession
Dim ufs As NXOpen.UF.UFSession = NXOpen.UF.UFSession.GetUFSession

' Get the tag of our face
Dim faceTag As NXOpen.Tag = myFace.Tag

' Get the uv mid-point of the face
Dim minU, maxU, minV, maxV, box(3), uv(1) As Double
ufs.Modl.AskFaceUvMinMax(faceTag, box)
minU = box(0) : maxU = box(1)
minV = box(2) : maxV = box(3)
uv = { (minU + maxU)/2, (minV + maxV)/2 }

' Create a structure to hold the evaluation results
Dim faceValues As New NXOpen.UF.ModlSrfValue

' Ask for position, first derivatives, and unit normal
Dim request As Integer = NXOpen.UF.UFConstants.UF_MODL_EVAL_UNIT_NORMAL

' Evaluate at uv mid-point
ufs.Modl.EvaluateFace(faceTag, request, uv, faceValues)

' Extract position and unit normal at point on face
Dim facePosition As Double() = faceValues.srf_pos
Dim faceNormal As Double() = faceValues.srf_unormal
```

As you can see, the first step is to get the parametric mid-point of the face. Of course, if we wanted to evaluate at some other point of the face, this step would not be necessary. By setting `request = UF_MODL_EVAL_UNIT_NORMAL`, we have asked for calculation of a position, first partial derivatives, and a unit surface normal, so these are available in the `faceValues` structure that is returned. Various other request constants are provided in the `UFConstants` class; the most comprehensive of these is `UF_MODL_EVAL_ALL`, which allows you to calculate position, surface normal, and all the partial derivatives up to the third order. There is a related function, `NXOpen.UF.UFModl.AskFaceProps`, that provides additional information about curvature.

Despite its name, the `EvaluateFace` function we used above is actually doing computations on a surface, rather than a face. So, when performing evaluations, you do not need to restrict yourself to *uv* values that correspond to locations inside the given face. Even the *uv* mid-point we used above is not guaranteed to lie within the face, because the face might have some hole or notch that excludes it.

### Face Topology Properties

Like an edge, a face has “topological” properties that describe its relationship to other objects in its body. If `myFace` is an `NXOpen.Face` object, then `myFace.GetBody` gives you the body that the face lies on, and `myFace.GetEdges` returns its array of edges..

## Face Geometry Properties

To get information about the geometry of a face, you use the `NXOpen.UF.UFModl.AskFaceData` function. For example, the following code gets information about a face `myFace`:

```
Dim ufs As NXOpen.UF.UFSession = NXOpen.UF.UFSession.GetUFSession
Dim axisPoint(2) As Double      ' Point on cylinder axis
Dim axisVector(2) As Double    ' Direction vector of cylinder axis
Dim box(5) As Double           ' 3D bounding box of face
Dim surfType As Integer        ' Surface type (see below)
Dim r1, r2 As Double           ' Radii of face (see below)
Dim flip As Integer            ' Normal flip indicator

ufs.Modl.AskFaceData(myFace.Tag, surfType, axisPoint, axisVector, box, r1, r2, flip)
```

The `box` argument provides a bounding box for the face, with axes aligned with the Absolute Coordinate System. The box is represented by 6 numbers in the order `minX, minY, minZ, maxX, maxY, maxZ`.

The `flip` argument is equal to  $\pm 1$ , and indicates on which side of the surface material lies. Specifically, if  $S^u$  and  $S^v$  are the first partial derivatives of the surface, then the vector  $flip * (S^u \times S^v)$  points away from material, into “air”. The meanings of the other parameters, for various different surface types, are given in the following table:

Face Type	Type	axisPoint	axisVector	r1	r2
Cylinder	16	Point on axis	Axis vector	Radius	---
Cone	17	Point on axis	Axis vector	Radius at axis point	Half-angle (in radians)
Sphere	18	Center	---	Radius	---
Revolved	19	Point on axis	Axis vector	---	---
Torus	19	Center	Axis vector	Major radius	Minor radius
Extruded	20	---	---	---	---
Plane	22	Point on plane	Normal	---	---
Blend	23	---	---	Radius	---
B-surface	43	---	---	---	---
Offset	65	---	---	---	---

There is another function `NXOpen.UF.UFModl.AskBsurf` that provides detailed information about b-surfaces.

# Chapter 10: Feature Concepts

The `NXOpen.Features` class contains a wide variety of functions for creating “features”. At one extreme, features can be very simple objects like blocks or spheres; at the other extreme, features like `ThroughCurveMesh` can be very complex. In this chapter, we explain what a feature is, and give some samples of the NX Open functions that create them. As usual, the full details can be found in the NX Open Reference Guide.

## ■ What is a Feature ?

Though you have probably created hundreds of features while running NX interactively, perhaps you never stopped to think what a “feature” really is. So, here is the definition ...

A feature is a collection of objects created by a modeling operation that remembers the inputs and the procedure used to create it.

The inputs used to create the feature are called its “parents”, and the new feature is said to be the “child” of these parents. This human family analogy can be extended in a natural way to provide a wealth of useful terminology. We can speak of the grandchildren or the ancestors or the descendants of an object, for example, with the obvious meanings. An object that has no parents (or has been disconnected from them) is said to be an “orphan”, or sometimes a “dumb” object, or an “unparameterized” one. The inputs and the procedure are also known as the “history” of the object, or the “recipe”, or the “parameters”. There is no shortage of terminology in this area.

The great power of features is that they capture the process (i.e. the history, or recipe) used to create an object. You can change the inputs, and then re-execute this process, which gives you some remarkable editing capabilities. You can also re-order features, delete them, or insert new ones in the middle of the “recipe”, which again provides very powerful editing techniques.

## ■ Types of Features

There are many different types of features, plus two important subclasses: Body Features and Curve Features. Some of the more common examples are listed in the table below:

Features	Body Features	Curve Features
AssociativeArc	Block	IntersectionCurve
AssociativeLine	BoundedPlane	IsoparametricCurve
CompositeCurve	Brep	OffsetCurve
CurveOnSurface	Cylinder	PointSet
DatumCsys	EdgeBlend	ProjectCurve
DatumFeature	ExtractFace	VirtualCurve
Helix	Extrude	
JoinCurves	FaceBlend	
PointFeature	Revolve	
StudioSpline	Scale	
Measure	ThroughCurves	
Extract	Tube	

Important properties and methods for the `NXOpen.Features.Feature` class are:

Member	Description
<code>FeatureType</code>	Returns the feature type as a String (see below)
<code>GetEntities</code>	Returns the entities created by the feature
<code>GetExpressions</code>	Returns the expressions created by the feature
<code>GetFeatureName</code>	Returns the displayed name of the feature.

<a href="#">GetParents</a>	Returns the immediate parent features
<a href="#">Suppress()</a>	Suppresses the feature
<a href="#">Suppressed</a>	Returns the suppression status of the feature
<a href="#">Timestamp</a>	Returns the feature's timestamp as an Integer

Some of the feature type strings are rather strange and cryptic, especially in older models; you may see things like [BREP](#), [CPROJ](#), [FRENET\\_DATUM\\_PLANE](#), [SKIN](#), [SWP104](#), [META](#), and so on. It's usually better to use the standard VB [TypeOf](#) or [GetType](#) operators to find out the type of a feature.

As the name suggests, a [BodyFeature](#) is a feature that produces a body or a collection of bodies as its result. Similarly, a [CurveFeature](#) typically produces curves (or points). So, these classes have some additional members. For example, a [BodyFeature](#) has [GetBodies](#), [GetFaces](#), and [GetEdges](#) functions, and a [CurveFeature](#) has [Color](#), [Font](#), and [Width](#) properties. For a [BodyFeature](#), the [GetEntities](#) function typically returns an array of length zero, so you should use the [GetBodies](#) function instead.

The following code cycles through the work part, writing out some information about each feature it finds:

```
For Each feat In workPart.Features
    Guide.InfoWriteLine("Type: " & feat.GetType.ToString)
    Guide.InfoWriteLine("Name: " & feat.GetFeatureName)
    Guide.InfoWriteLine("Timestamp: " & feat.TimeStamp)
    Guide.InfoWriteLine("NumParents: " & feat.GetParents.Length)
    Guide.InfoWriteLine("NumExpressions: " & feat.GetExpressions.Length)
Next
```

## ■ Feature Display Properties

An [NXOpen.Features.Feature](#) is not an [NXOpen.DisplayableObject](#), so its color, hidden/shown property, layer assignment, and other display attributes are not handled in the standard way. You can actually change the color of a feature using an [NXOpen.Features.ColorFeatureBuilder](#), but it's often better to proceed via first principles, as explained below. The key idea is that a feature typically "owns" some constituent objects (like bodies and curves), which are often known as its "outputs". The output objects do have display properties, so you can use them to (indirectly) modify the display of the feature. You can get these output objects by calling the [GetBodies](#) or [GetEntities](#) functions mentioned above.

A couple of examples should make this more clear. First, suppose you created a Block feature. You cannot directly change the color of this feature in the usual way. However, the Block feature owns a solid body (which you can get by calling [GetBodies](#)). You can change the color of this body, and this will effectively change the color of the feature.

Another example: suppose you created a Hole feature. You can't change the color of the Hole in the usual way, but you can get its faces and change their colors, instead. In fact, you might decide to assign different colors to different faces of the hole. The code below provides a more interesting example involving a feature with two bodies:

```
'Create two circles, and extrude them
Dim disk0 As NXOpen.Arc = NXOpen.Guide.CreateCircle(0,0,0, 2)
Dim disk1 As NXOpen.Arc = NXOpen.Guide.CreateCircle(0,5,0, 1)
Dim pegs As NXOpen.Features.Extrude = ' <Extrude the circles>

'Get the two displayable objects of the Extrude feature (two bodies)
Dim bodies As NXOpen.Body() = pegs.GetBodies

' Change their colors
bodies(0).Color = 186 ' Usually red, by default
bodies(1).Color = 211 ' Usually blue, by default
```

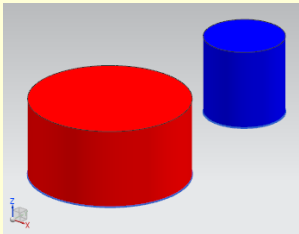

## ■ Using Features and Bodies

As we saw above, when working with display properties, we have to be careful to make the distinction between a feature and its constituent bodies. Next we will see that this distinction is also relevant in modeling.

There are many modeling and computation functions that expect to receive bodies as input. Examples are Boolean operation functions, trimming, splitting, computing mass properties, and so on. Since most of the basic creation functions produce features, the output of these functions will not be immediately usable unless we make some accommodation.

For example, consider the following code:

```
Dim s1 As NXOpen.Features.Sphere = NXOpen.Guide.CreateSphere(0,0,0, 1)
Dim s2 As NXOpen.Features.Sphere = NXOpen.Guide.CreateSphere(1,0,0, 2)
Dim union As NXOpen.Features.BooleanFeature = NXOpen.Guide.Unite(s1, s2) ' Doesn't work
Dim volume As Double = ' <Compute volume of union> ' Doesn't work
```

The `Unite` function expects two bodies as input, but `s1` and `s2` are features, so the operation will not work. Similarly, the function that computes volume expects to receive a body, so this won't work, either. We can fix the code, by getting bodies from the features before performing the unite or the volume calculation. So, the corrected version of the code above is:

```
Dim s1 As NXOpen.Features.Sphere = NXOpen.Guide.CreateSphere(0,0,0, 1)
Dim s2 As NXOpen.Features.Sphere = NXOpen.Guide.CreateSphere(1,0,0, 2)

Dim sb1 As NXOpen.Body = s1.GetBodies(0)
Dim sb2 As NXOpen.Body = s2.GetBodies(0)
Dim union As NXOpen.Features.BooleanFeature = NXOpen.Guide.Unite(sb1, sb2)

Dim unionBody As NXOpen.Body = union.GetBodies(0)
Dim volume As Double = ' <Compute volume of unionBody>
```

## ■ Units

The parameters of features are typically described by expressions, as discussed below. But expressions involve units, so first we have to understand units.

In each part file, there is a `UnitCollection`, which has an associated collection of “measures”. Typical measures are things like length, volume, mass, angle, or velocity. These are also called Dimensionality in the NX docs. Then each measure has an associated collection of units, which are objects of type `NXOpen.Unit`. Among these units, one particular one is singled out as the `BaseUnit` for that measure. For example, in a metric part, the Base Unit for the measure “Length” will be millimeters; this is the length unit that is actually used for representing objects in the part file. Typically, we obtain the measures and units for the `UnitCollection` of the work part using code like this:

```
' Get the UnitCollection of the work part
Dim unitCollection As NXOpen.UnitCollection = workPart.UnitCollection

' Get the measures of this UnitCollection -- "Length", "Area", "Mass", etc.
Dim measureTypes As String() = unitCollection.GetMeasures

' Get the available units for the measure "Length"
Dim units As NXOpen.Unit() = unitCollection.GetMeasureTypes("Length")

' Get the base unit for the measure "Length"
Dim baseUnit As NXOpen.Unit = unitCollection.GetBase("Length")
```

A `UnitCollection` will generally contain a large number of measures (80 or more). A few of the less exotic ones, together with their base unit names, are as follows:



Measure	Base Unit Name	A Few Other Unit Names
Length	MilliMeter	Meter, Inch, Feet, KiloMeter, Mile, Micron, Angstrom
Area	SquareMilliMeter	SquareMeter, SquareInch, SquareFeet, SquareCentiMeter
Volume	CubicMilliMeter	CubicMeter, CubicInch, CubicFeet, CubicCentiMeter
Mass	Kilogram	Gram, Tonne, Slug, PoundSecondsSquaredPerInch, PoundMass
Mass Density	KilogramPerCubicMilliMeter	GramPerCubicCentiMeter, SlugsPerCubicFeet
Time	Second	Minute, Hour
Angle	Degrees	Radian, Revs
Velocity	MilliMeterPerSecond	MeterPerSecond, FeetPerSecond, KiloMeterPerHour, FeetPerMinute
Force	MilliNewton	Newton, PoundForce, Poundal
Temperature	Celsius	Fahrenheit, Kelvin, Rankine
Energy	MicroJoule	EnergyPoundForceInch, Joule, Btu

You can use the unit names to obtain other units (other than the base units) from the [FindObject](#) function

```
' Get the units named "MilliMeter", "Radian", and "Kilogram"
Dim mmUnit As NXOpen.Unit = workPart.UnitCollection.FindObject("MilliMeter")
Dim radianUnit As NXOpen.Unit = workPart.UnitCollection.FindObject("Radian")
Dim kgUnit As NXOpen.Unit = workPart.UnitCollection.FindObject("Kilogram")
```

Note that the names used here are case sensitive — for example, you have to use “MilliMeter”, not “Millimeter”, and “Kilogram” rather than “kilogram” or “KiloGram”.

## Expressions

Expressions are used to control the sizes and positions of features, so it’s important for us to know how to work with them. The general form of an expression is

$$\text{name} = \text{right-hand-side}$$

To understand the details, let’s look at some example expressions defined in interactive NX:

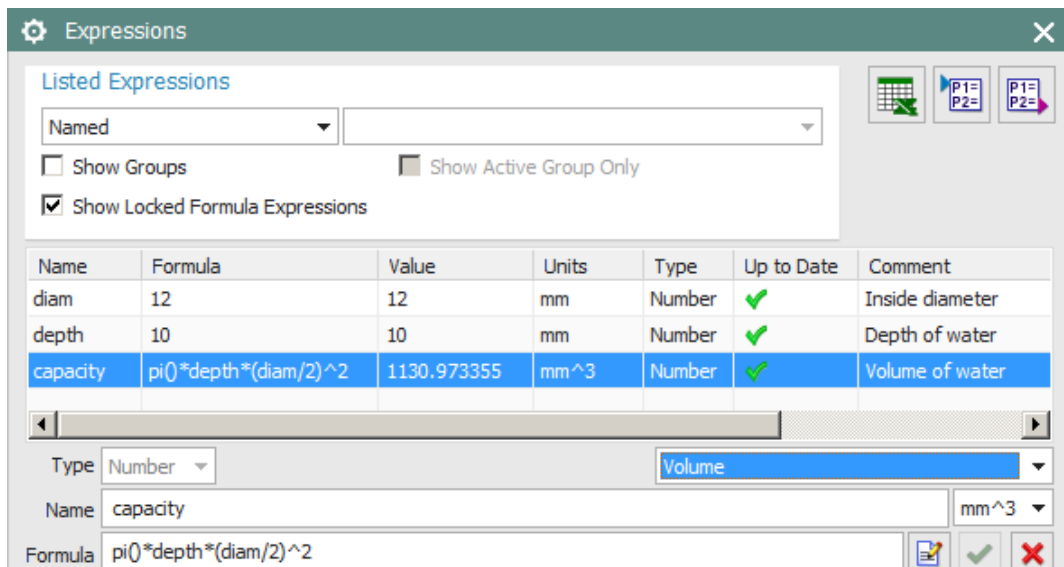

The third of these is the most interesting. It has three important pieces, indicated by the colored boxes:

$$\text{capacity} = \pi() * \text{depth} * (\text{diam}/2)^2 \quad // \text{ Volume of water}$$

The overall text string is called the “equation” of the expression (the pink box), the portion to the left of the equals sign is called the “name” (the green box), and the portion to right of the equals sign is called the “right-hand side” (the yellow box). So, in this example:

- Equation is: “capacity = pi()\*depth\*(diam/2)^2 // Volume of water”
- Name is: “capacity”
- Right-hand-side is: “pi()\*depth\*(diam/2)^2 // Volume of water”

As you can see, the right-hand-side includes a comment that is delineated by two slash characters. The portion of the right-hand-side preceding the comment must be a legal formula involving numbers, functions, and names of other expressions.

NX builds many expressions behind the scenes as you create features. Expressions created this way will typically look something like this:

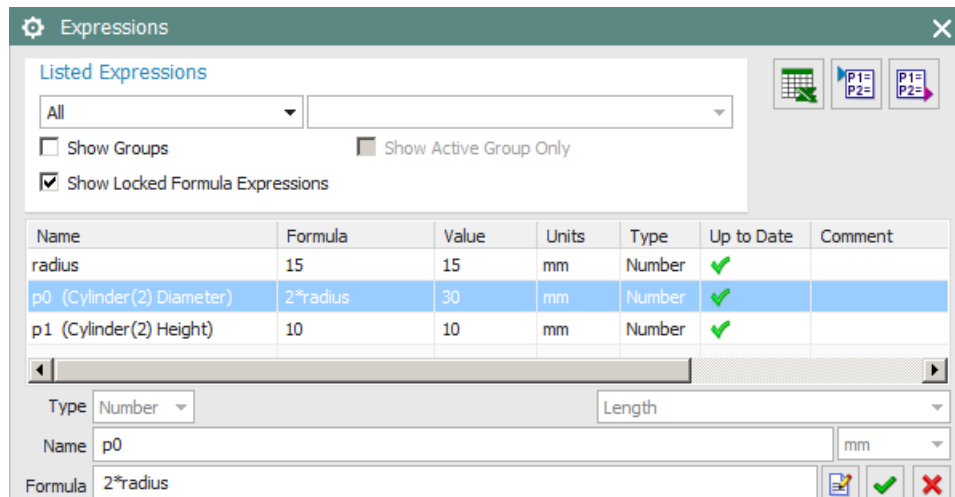

The second expression has a simple name (just “p0”), which was made up by NX. But there is also some extra text in parentheses following this name. This extra text is called the “description” of the expression, and it consists of a feature name plus a “descriptor” indicating which feature parameter the expression controls. In summary:

String	Name	Meaning
p0	Name	The name of the expression (made up by NX)
Diameter	Descriptor	Indicates that this expression controls a diameter parameter
(Cylinder(2) Diameter)	Description	Specifically, it controls the diameter of Cylinder(2)

If an expression does not control a feature, then its Description and Descriptor strings will be empty (zero length strings). All of these various elements of an expression can be controlled using NX Open functions, as follows:

Function/Property	Purpose
Description	Gets the description of the expression
EditComment()	Changes the comment.
Equation	Returns the equation of the expression in the form: name = right_hand_side.
GetDescriptor()	Returns the descriptor for the expression
GetValueUsingUnits()	Get the value of the expression, in either base units or the expression's units.
Name	Gets the name of the expression
RightHandSide	Returns or sets the right hand side of the expression.
SetName()	Sets the name of the expression.
Type	A string indicating the type of expression, which can be Number, String, Integer, Boolean, Vector, Point, or List.
Units	Returns or sets the units for the expression.
Value	Returns or sets the value of the expression in base units.

Note that setting the **Value** property will also change the value of the **RightHandSide** property. For example, if you set **Value = 3.5**, then the **RightHandSide** string will become "3.5". Similarly, setting the **RightHandSide** property will cause the **Value** property to change accordingly.

The following code cycles through all the expressions in the work part and writes out some of their properties:

```

For Each exp As NXOpen.Expression In workPart.Expressions
    Dim sep = " ; "
    Guide.InfoWrite(exp.Name & sep)
    Guide.InfoWrite(exp.Equation & sep)
    Guide.InfoWrite(exp.Description & sep)
    Guide.InfoWrite(exp.GetDescriptor & sep)
    Guide.InfoWriteLine(exp.Value)
Next

```

If we execute this code with a work part that contains the following three expressions

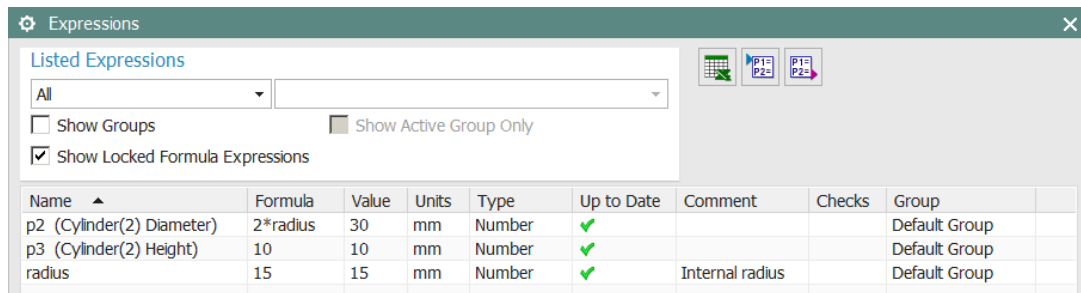

the results will be:

Name	Equation	Description	Descriptor	Value
p2	p0=2*radius	(Cylinder(2) Diameter)	Diameter;	30
p1	p1=10	(Cylinder(2) Height)	Height;	10
radius	radius=15 //Internal radius			15

The radius expression does not (directly) control a feature, so its Description and Descriptor strings are empty. Also, note the mysterious semi-colon at the end of the two descriptor strings.

## ■ Creating Expressions

Functions for creating expressions are provided in the ExpressionCollection class, as follows:

Function	Creates ...
Create(String)	An expression
CreateExpression(String, String)	An expression of the specified type.
CreateWithUnits(String, Unit)	An expression with units.
CreateSystemExpression(String)	A system expression.
CreateSystemExpression(String, String)	A system expression of the specified type.
CreateSystemExpressionWithUnits(String, Unit)	A system expression with units.

When creating expressions of a specified type, the type is indicated by a string, which can be one of "Number", "String", "Boolean", "Integer", "Point" or "Vector". The following code shows how these functions are used:

```

Dim mmUnit As NXOpen.Unit = workPart.UnitCollection.GetBase("Length")
Dim cmUnit As NXOpen.Unit = workPart.UnitCollection.FindObject("CentiMeter")

' Get the ExpressionCollection of the work part
Dim exps As NXOpen.ExpressionCollection = workPart.Expressions

' Create three expressions
Dim exp1 = exps.Create("x1 = 4")
Dim exp2 = exps.CreateExpression("Integer", "n2 = 4")
Dim exp3 = exps.CreateWithUnits("x3 = n2 + sqrt(n2)", mmUnit)

' Create three system expressions
Dim sysExp4 = exps.CreateSystemExpression("x4 = 7")
Dim sysExp5 = exps.CreateSystemExpression("Integer", "n5 = 9")
Dim sysExp6 = exps.CreateSystemExpressionWithUnits("x6 = n5 + 2.75", cmUnit)

```

System expressions are less permanent than ordinary (non-system) ones. A system expression will be deleted when the last feature using it is deleted, and it will also be deleted by the Delete Unused Expressions function, which is usually the behavior that's desirable.

If you don't specify a unit when creating an expression, or you specify a unit of **Nothing**, you get an expression that is "constant". Despite the name, this doesn't mean the expression value is fixed, it just means that it represents a dimensionless quantity, like an angle or a parameter percentage on a curve.

So, the most useful function of the six mentioned above is `CreateSystemExpressionWithUnits`, and you will see this function many times in recorded journals.

When writing code that creates expressions, you have to bear in mind that they must have unique names. This can be inconvenient during debugging — if you run the same code twice in the same part file, you'll get an error message telling you that "The specified expression variable already exists". To avoid this, delete the previously created expressions before re-executing your code.

## ■ Using Expressions to Define Features

In chapter 8, we saw many examples of code defining the values of feature parameters. Typically, it looked something like the following:

```

' Create a CylinderBuilder
Dim builder = workPart.Features.CreateCylinderBuilder(Nothing)

' Define the cylinder diameter and height
builder.Diameter.RightHandSide = "4.0"
builder.Height.RightHandSide = "6.0"

```

This will cause the creation of two expressions that we can use to modify the diameter and height of the cylinder, but this form of editing is rather dull and uninteresting. Suppose we wanted a more intelligent cylindrical container that let us specify its depth and volume, and then calculated the required diameter. We could achieve this with the following code:

```

Dim volume = 100
Dim depth = 4
Dim pi = System.Math.PI
Dim diameter = 2 * System.Math.Sqrt( volume / (depth*pi) )

builder.Height.RightHandSide = depth.ToString
builder.Diameter.RightHandSide = diameter.ToString

```

We have now defined the diameter of the cylinder as a function of its depth and volume:

$$\text{diameter} = 2 \sqrt{\frac{\text{volume}}{\text{depth} * \pi}}$$

So, we could display a small dialog asking the user to enter the desired volume and depth, and the code above would create a cylindrical container with the correct volume. However, this would still produce a relatively “dumb” NX model — if the user subsequently edited the cylinder’s height or diameter in interactive NX, the volume would no longer be correct. We have the right “intelligence” in our code, but it did not get transferred into the NX model we built. If we want to build models that support convenient interactive editing, we need to use expressions to build in the desired behavior. We could achieve this as follows:

```
Dim mmUnit As NXOpen.Unit = workPart.UnitCollection.GetBase("Length")
Dim mm3Unit As NXOpen.Unit = workPart.UnitCollection.GetBase("Volume")

workPart.Expressions.CreateSystemExpressionWithUnits("volume = 100", mm3Unit)
workPart.Expressions.CreateSystemExpressionWithUnits("depth = 4", mmUnit)
Dim formula As String = "diameter = 2* sqrt( volume / (depth*pi()) )"
workPart.Expressions.CreateSystemExpressionWithUnits(formula, mmUnit)

builder.Height.RightHandSide = "depth"
builder.Diameter.RightHandSide = "diameter"
```

The two code examples show two different ways to capture “intelligence”: in the first case the intelligence is solely in our code, and in the second case it has been captured in expressions. The first approach is simpler, but the code will need to be re-executed if any of the inputs change. In the second approach, the logic in our code has essentially been replicated with NX expressions, which will “replay” automatically if any inputs change.

# Chapter 11: Assemblies

## Introduction

Unless you're in the brick business, most of your products will probably be assemblies — combinations of simpler lower-level items, rather than just homogeneous hunks of material. This chapter outlines how NX represents assemblies, and describes the NX Open functions that you can use to work with them. Most of the discussion is related to reading information about assemblies, rather than creating them, since the most common applications involve extracting information and writing reports of one sort or another. Typically, your code will traverse through the items in an assembly, gathering information (from attributes, usually), and writing this into a report document of some kind.

Many of the code examples given below are just fragments, as usual. Complete working code and the part files for a simple car assembly are provided in the folder [...\NX]\UGOPEN\SNAP\Examples\More Examples\CarAssembly.

Note that some of the code in this chapter will work properly only if the car assembly is fully loaded.

## The Obligatory Car Example

Following the time-honored traditions of assembly modeling, we will use a simple car as an example throughout this chapter (though this version looks more like a van, actually).

Descriptive Part Name	Component Name	Part Name
Sections		
Car_Assembly		Car_Assembly
Wheel_Part	SPARE_WHEEL	Wheel_Part
Engine_Part	ENGINE	Engine_Part
Axle_Assembly	REAR_AXLE	Axle_Assembly
Wheel_Part	REAR_RIGHT_WHEEL	Wheel_Part
Wheel_Part	REAR_LEFT_WHEEL	Wheel_Part
Axle_Assembly	FRONT_AXLE	Axle_Assembly
Wheel_Part	FRONT_RIGHT_WHEEL	Wheel_Part
Wheel_Part	FRONT_LEFT_WHEEL	Wheel_Part

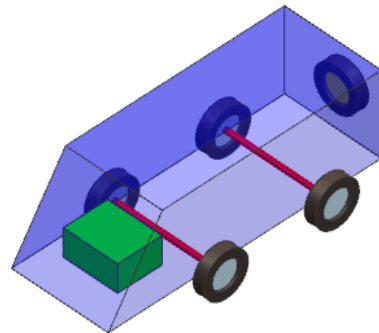

As you can see, the car consists of an engine (the green block), an exterior shape (the blue thing), two axles, and a spare wheel. Each axle consists of a shaft and two wheels. The exterior shape is a sheet body in Car\_Assembly.prt, so you don't see it in the Assembly Navigator. Similarly, the red shaft is a solid body in Axle\_Assembly.prt, so you don't see this, either.

## Trees, Roots, and Leaves

Let's use our car model to explain some terminology. Graphically, its structure looks like this:

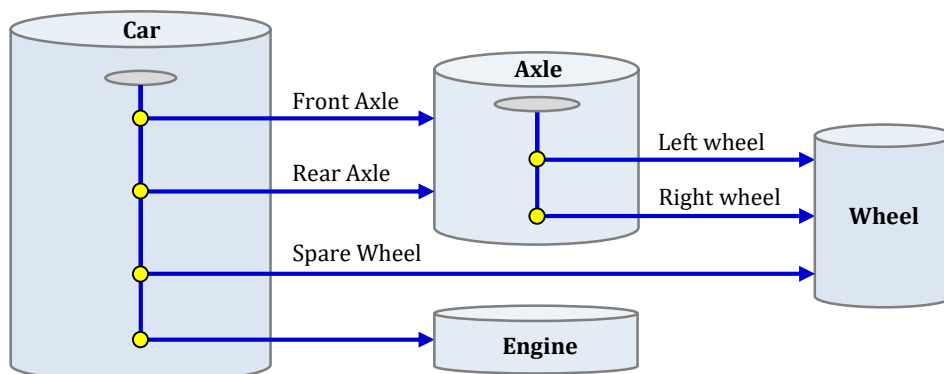

This diagram accurately reflects the structure of the data stored in NX. Notice that the wheel part is stored only once, even though the car has five wheels (the four main ones and a spare).

However, diagrams like this are difficult to draw, in more complex situations, so we will usually draw them as shown below, instead, with items repeated:

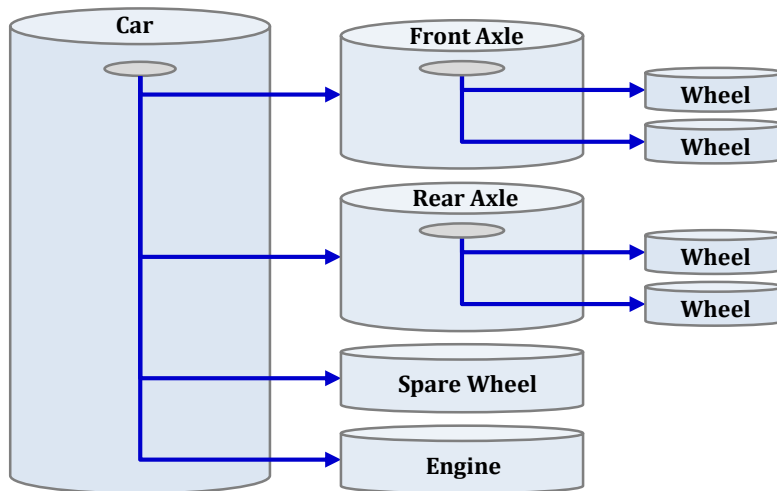

The top-level car assembly has four subassemblies: two axles, a spare wheel, and an engine. The axle assembly, in turn, has two subassemblies, namely its left and right wheels. In this situation, the axles, spare wheel and engine are said to be **children** of the car assembly. Or looking at it the other way around, the car assembly is said to be the **parent** of each of these four. This human-family terminology can be extended further: we might say that each of the four main wheels is a grandchild of the car assembly, and all the parts shown are **descendants**, and so on.

Note that this is the reverse of feature terminology. In the feature modeling world, if object-A and object-B are constituents of object-C (in the sense that they are used to create object-C), then they are called the parents of object-C, not its children. This inconsistency is unfortunate, but it's very well established, and is not likely to change, so we have to live with it.

In addition to the parent-child terminology, there are some useful terms that we can borrow from computer science. A computer scientist would regard the assembly structure as a **tree**, and the various parts and assemblies would be called the **nodes** in the tree. The node at the top of a sub-tree (denoted by the  symbol in the diagram) is called the **root** node of that sub-tree. Nodes at the bottom (like the wheels and engine) are called **leaf** nodes; these are easy to identify because they have no children. Trees in computer science are strange — their roots are always at the top, and their leaves are at the bottom ☺.

In engineering, a leaf node in an assembly tree is sometimes referred to as a piece part. This is a somewhat misleading term because it suggests that the part consists of a single solid body, which is not always true. To avoid any possible misunderstandings, we will use the term “leaf” in this document.

We can measure the **depth** of a node in a tree by counting its ancestors, including parents, grandparents, and so on, up to the root node of the tree. So, in our car example, the car itself is at depth zero, the axles and engine are at depth = 1, and the four main wheels are at depth = 2. In NX documentation, nodes with depth = 1 (i.e. immediately below the root node) are sometimes known as “top level” nodes.

## ■ Components and Prototypes

Suppose we have an assembly, and we want to write out a report describing its structure. Each part knows about its child subassemblies, so we could do this by writing code that “walks” from part to part, recording the parent-child relationships. We would start at the top of the tree with the car assembly file. Using the information in this file, we would find out that there are four children, and we could “walk” to each of these four children to get information about grandchildren, and so on. This process would certainly work, but it has a problem — we have to open each part file so that we can look inside to get information about its children. Opening hundreds of part files might be very slow (depending on their locations), and we may not even have permission to open some of them, so we need a better way.

The NX solution is to store a replica of the assembly tree within each part file, as shown here:

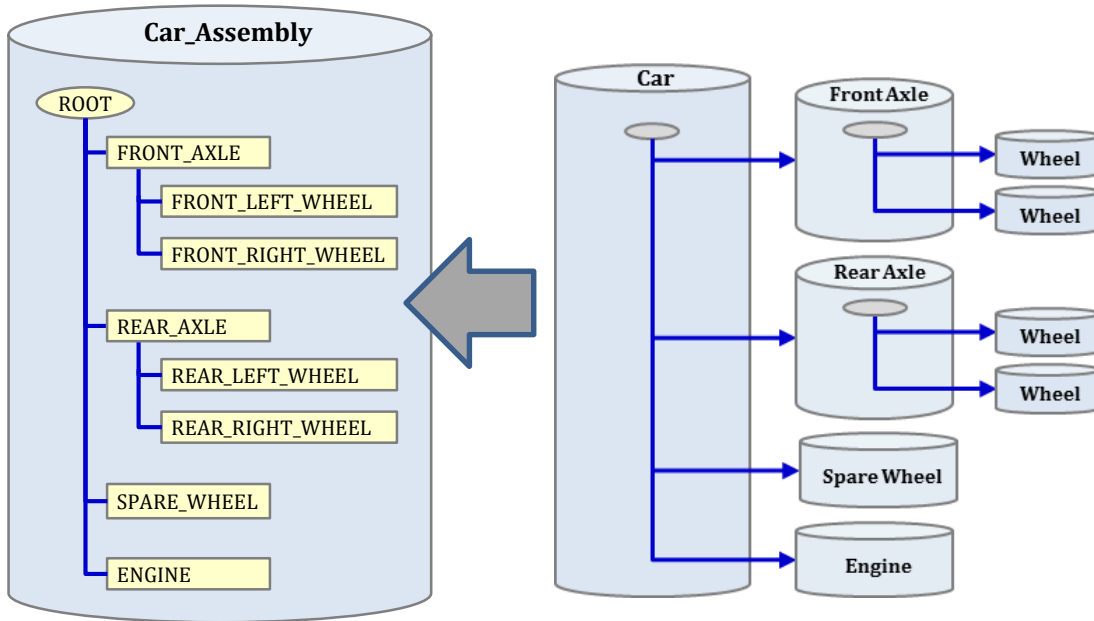

The yellow items are called “**Components**” or sometimes “**Part Occurrences**”. The tree of components inside a part file replicates the tree structure of the subassemblies themselves. So, if we want to know about this structure, we can simply traverse through the tree of component objects in the file, without opening any other part files.

An NX part file that represents an assembly has a **ComponentAssembly** object that provides most of the functions related to assemblies. The ComponentAssembly object has a **RootComponent** object, which serves as the root node for the part’s tree of components. You can get to all the other components in the part file by traversing downwards from the RootComponent. The RootComponent will be **Nothing** if the part file is not an assembly.

Each component contains a list of links to its children, a link to its parent, and a link to the corresponding part file, which is called the **Prototype** of the component. In the diagram below, the parent-child relationships are shown by the blue lines, and the component-to-prototype links are shown as red arrows:

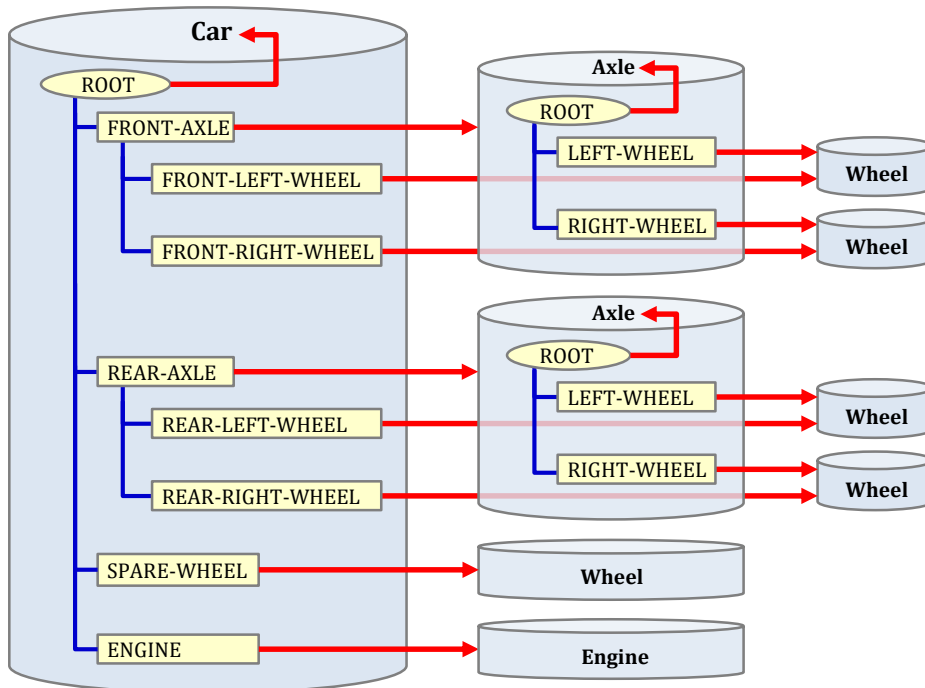

So, for example, as you can see, the axle part is the prototype corresponding to each of the components **FRONT\_AXLE** and **REAR\_AXLE**. Or, looking at it the other way around, **FRONT\_AXLE** and **REAR\_AXLE** are occurrences of the axle part.



As mentioned before, a root component is not a “real” component, so its prototype link has a special meaning — it “loops back” and refers the part in which the root component resides.

This correspondence between components and their associated prototype parts is also displayed in the Assembly Navigator, as shown here:

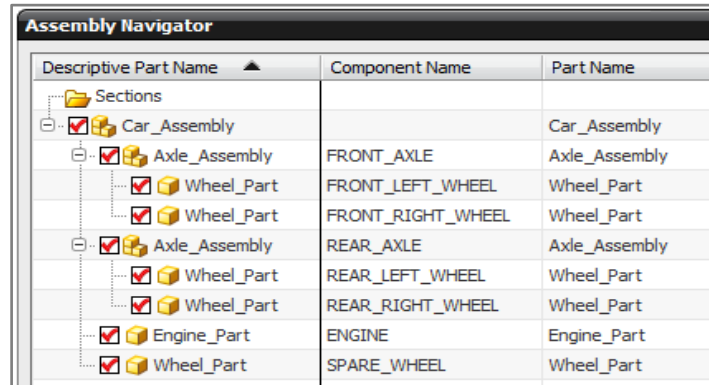

In NX Open, components are represented by `NXOpen.Assemblies.Component` objects, whose most important properties and methods are summarized in the table below:

Property or Method	Description
<code>Parent</code>	Gets the parent component of this component
<code>GetChildren</code>	Returns an array containing the child components of this component
<code>Prototype</code>	The prototype part of this component
<code>GetPosition</code>	Gets the position/orientation of this component in the parent part (discussed later)

Many additional properties and methods are inherited from `NXOpen.DisplayableObject`. For example, you can change the color of a component, hide it, move it between layers, assign attributes to it, and so on.

## ■ Cycling Through An Assembly

There are many situations where it is useful to cycle through all the subassemblies of a given assembly, doing some operation on each of them. To do this, you use a programming technique called recursion. The basic idea is to write a recursive function, which is one that calls itself. This might sound like a strange idea, but it provides a very convenient way of traversing a tree, as in the following code:

```
Public Shared Sub Main()
    Dim session = NXOpen.Session.GetSession
    Dim workPart As NXOpen.Part = session.Parts.Work
    Dim root = workPart.ComponentAssembly.RootComponent
    DoSomething(root)
End Sub

Public Shared Sub DoSomething(comp As NXOpen.Assemblies.Component)
    Guide.InfoWriteLine(comp.Name)
    For Each child In comp.GetChildren
        DoSomething(child)
    Next
End Sub
```

As you can see, the `DoSomething` function is recursive — it calls itself. So, what happens when the system executes the line of code that says `DoSomething(root)` in the `Main` function? Well, first of all, the name of the root component will be written out. Then, `DoSomething` is applied to each of the children of root, causing their component names to be written out. But, then, through the magic of recursion, applying `DoSomething` to a child causes `DoSomething` to be applied to its children, in turn, and so on. In the end, the result is that `DoSomething` gets applied to all the descendants of root, so all of their names are written to the Info window. Of course, in practice, you would probably replace the `Guide.InfoWriteLine` call with some more interesting code, but the principle would be exactly the same.

## ■ Indented Listings

Listings of parts in an assembly are easier to understand if they are indented, since the indentation makes the hierarchical structure more visible. First, a simple function that creates a string of spaces for use in indenting:

```
Public Shared Function Indent(level As Integer) As String
    Dim space As Char = " "c
    return new String(space, 3*level)      ' Indent 3 spaces for each level
End Function
```

Once we have this function, creating indented listings is straightforward. The key is to keep track of our current “depth” as we cycle through the assembly. We use a global variable called `Depth` to do this. So, each time we descend a level, we increment our depth (`Depth = Depth + 1`), and each time we pop back up a level, we decrement it (`Depth = Depth - 1`). We modify our `DoSomething` function as follows:

```
Public Shared Sub DoSomething(comp As NXOpen.Assemblies.Component)
    Depth = Depth + 1
    Dim indentString As String = Indent(Depth)
    Dim compName As String = comp.Name
    Guide.InfoWriteLine(indentString & compName)
    For Each child In comp.GetChildren
        DoSomething(child)
    Next
    Depth = Depth - 1
End Sub
```

Then, if we make `Car_Assembly.prt` our work part, and call this function recursively, as before, we get the following nicely indented listing:

```
ENGINE
SPARE_WHEEL
REAR_AXLE
    REAR_RIGHT_WHEEL
    REAR_LEFT_WHEEL
FRONT_AXLE
    FRONT_RIGHT_WHEEL
    FRONT_LEFT_WHEEL
```

## ■ Component Positions & Orientations

When you insert a part into an assembly, it is typically re-positioned and re-oriented somehow. The position and orientation information is held within an NX component object, and you can retrieve it as follows:

```
Public Shared Sub DoSomething(comp As NXOpen.Assemblies.Component)
    Dim pt As NXOpen.Point3d
    Dim mx As NXOpen.Matrix3x3
    comp.GetPosition(pt, mx)
    Dim axisZ As New NXOpen.Vector3d(mx.Zx, mx.Zy, mx.Zz)

    Guide.InfoWrite(comp.Name)
    Guide.InfoWrite( "; Position = " & pt.ToString)
    Guide.InfoWrite( "; AxisZ = " & axisZ.ToString & vbCrLf)

    For Each child In comp.GetChildren
        DoSomething(child)
    Next
End Sub
```

If you run this code with the car assembly as your work part, the resulting listing will include the following (tidied up a little to improve legibility):

ENGINE;	Position = [X=0,Y=0,Z=0];	AxisZ = [X=0,Y=0,Z=1]
SPARE_WHEEL;	Position = [X=0,Y=3045,Z=650];	AxisZ = [X=0,Y=1,Z=0]
REAR_AXLE;	Position = [X=0,Y=2000,Z=0];	AxisZ = [X=0,Y=0,Z=1]
REAR_RIGHT_WHEEL;	Position = [X=-950,Y=2000,Z=0];	AxisZ = [X=-1,Y=0,Z=0]
REAR_LEFT_WHEEL;	Position = [X=950,Y=2000,Z=0];	AxisZ = [X=1,Y=0,Z=0]
FRONT_AXLE;	Position = [X=0,Y=0,Z=0];	AxisZ = [X=0,Y=0,Z=1]
FRONT_RIGHT_WHEEL;	Position = [X=-950,Y=0,Z=0];	AxisZ = [X=-1,Y=0,Z=0]
FRONT_LEFT_WHEEL;	Position = [X=950,Y=0,Z=0];	AxisZ = [X=1,Y=0,Z=0]

To understand what this means, let's first look at how the wheel part itself was designed. The left-hand picture below shows a section view in the wheel part. As you can see, the inside center of the rim (the purple point labeled "P") is at the origin, and the rotational axis of the wheel is along the z-axis.

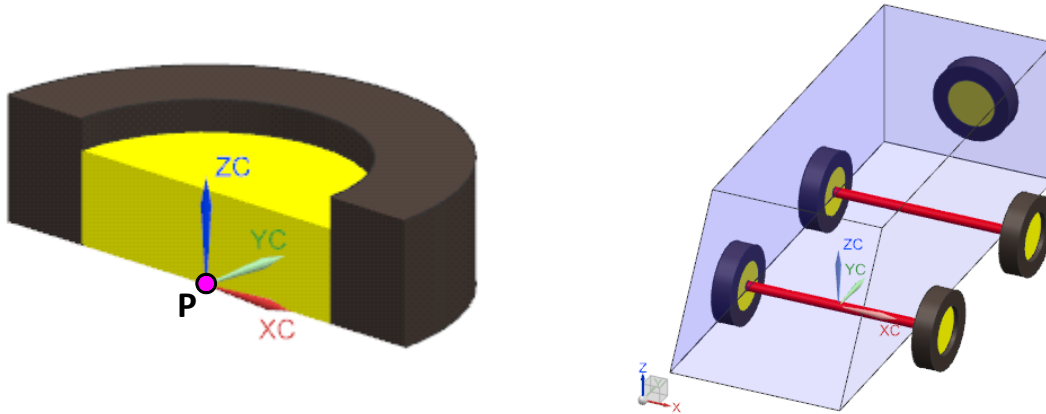

When the front left wheel gets inserted into the car assembly, this point P gets placed at (950, 0, 0). So, if `comp` is the FRONT\_LEFT\_WHEEL component, then `comp.Position` is (950, 0, 0). Similarly, the REAR\_LEFT\_WHEEL component has `Position` = (950, 2000, 0).

Orientations are a bit more interesting: when the front left wheel gets inserted into the car assembly, its z-axis gets aligned with the x-axis of the car. So, the z-axis of the orientation of the FRONT\_LEFT\_WHEEL component is (1, 0, 0). On the right-hand side of the car, the wheel is flipped, of course, so the FRONT\_RIGHT\_WHEEL has its `AxisZ` in the opposite direction, equal to (-1, 0, 0). Similarly, the SPARE\_WHEEL component has an orientation whose z-axis is (0, 1, 0).

We could also study the x-axis and the y-axis of the orientations of various components, of course. But, in the case of an axi-symmetric object like a wheel, these are not important.

## ■ Object Occurrences

When a part is inserted into an assembly, we know that an occurrence of this part (i.e. a component object) gets created in the parent assembly. But, the story doesn't end there. In addition to the occurrence of the inserted part itself, the system also creates occurrences of all the objects inside it.

(Technically, this is an oversimplification, the system creates occurrences of *some* of the objects, not all of them. But for the purposes of this section we will pretend it creates occurrences of all the objects. The real situation will be discussed in the later section "Reference Sets".)

To understand what happens, let's look at the structure of the Axle part in our car example. As we know, this part contains a solid body representing a shaft, plus two components (LEFT\_WHEEL and RIGHT\_WHEEL) which are occurrences of Wheel\_Part. The wheel part contains two solid bodies called TIRE\_BODY and RIM\_BODY. The structure is shown in the diagram below:

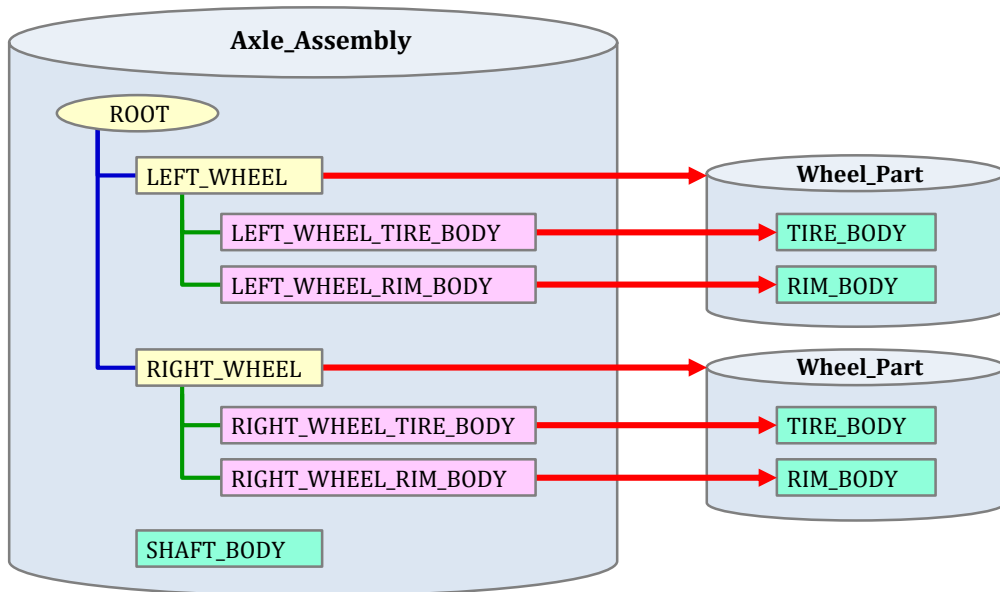

Looking at the top half of the diagram, we see that the wheel part has been inserted into the axle assembly. As a result of this, a part occurrence called LEFT\_WHEEL has been created in the Axle Assembly part. But, in addition to this, we see the pink boxes, LEFT\_WHEEL\_TIRE\_BODY and LEFT\_WHEEL\_RIM\_BODY. These are **object occurrences**; LEFT\_WHEEL\_TIRE\_BODY is an occurrence of TIRE\_BODY, and LEFT\_WHEEL\_RIM\_BODY is an occurrence of RIM\_BODY. We say that these object occurrences are **members** of the LEFT\_WHEEL component, as indicated by the green lines. The red arrows show how part and object occurrences both refer back to the original objects, which are called their **prototypes**. Only solid bodies are shown in the diagram, but, in fact, the LEFT\_WHEEL component will have members that are occurrences of **all** the objects in the wheel part (datums, wireframe geometry, etc.).

In many ways, the LEFT\_WHEEL\_TIRE\_BODY occurrence looks and behaves just like a normal solid body in the axle part. You can blank it, move it to another layer, assign attributes to it, or even calculate its weight and center of gravity. But, on the other hand it is fundamentally different from SHAFT\_BODY, which is a “real” solid body. The difference is that SHAFT\_BODY includes its own geometric data, whereas LEFT\_WHEEL\_TIRE\_BODY merely has links to geometric data that actually reside in the wheel part. So, in some sense, an occurrence is a “phantom” or “proxy” object, rather than a “real” one. Or, borrowing some terminology from Microsoft Office products, we might say that an occurrence is a “linked” object, whereas a “real” object like SHAFT\_BODY is an “embedded” one. The technology used in NX is completely different, but the basic concept is similar.

The diagram below shows the difference between the data structures of occurrence and “real” objects, using a simple example of three point objects in the axle and wheel parts:

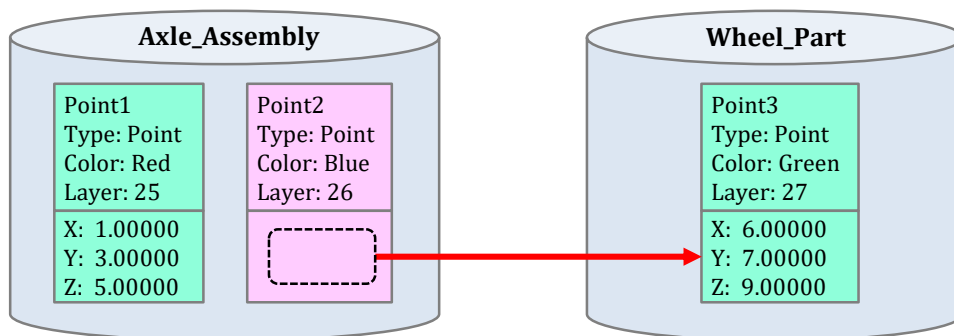

Point1 is embedded in the axle part, and Point2 is an occurrence whose prototype (Point3) resides in the wheel part. As usual, green boxes denote “real” embedded objects and pink ones denote occurrences. As you can see, Point2 has a color and a layer, but it has no coordinate data of its own. Whenever we ask for the coordinates of Point2, they will be derived by suitably transforming the coordinates of Point3.

The diagram above illustrates another important fact: even though Point2 is an occurrence, its object type is still “Point”. There is no special “occurrence” type in NX; any NX object can either be an occurrence (a linked object), or a “real” local embedded one. An NXOpen.NXObject has a property **IsOccurrence**, which allows you to find out whether or not it’s an occurrence. Then, if **IsOccurrence** is True, there are **ProtoType** and **OwningComponent** properties with the obvious meanings.

To find object occurrences, we need to use an NXOpen.UF function to cycle through a part. This cycling function works with tags, so first let's create a little helper function that gets an NXOpen.NXObject from a tag:

```
Public Shared Function ObjectFromTag(tag As NXOpen.Tag) As NXOpen.NXObject
    Dim obj As NXOpen.TaggedObject = NXOpen.Utilities.NXObjectManager.Get(Tag)
    Dim nXObject As NXOpen.NXObject = CType(obj, NXOpen.NXObject)
    Return nXObject
End Function
```

Then you can use the following code to cycle through the work part reporting on object occurrences:

```
Dim ufs As NXOpen.UF.UFSession = NXOpen.UF.UFSession.GetUFSession
Dim nextTag As NXOpen.Tag = NXOpen.Tag.Null
Dim obj As NXOpen.NXObject = Nothing

Do
    nextTag = ufs.Obj.CycleAll(workPart.Tag, nextTag)
    If nextTag = NXOpen.Tag.Null Then Return
    obj = ObjectFromTag(nextTag)
    If obj.IsOccurrence And TypeOf obj Is NXOpen.Body
        Dim occName As String = obj.Name
        Dim protoName As String = obj.Prototype.Name
        Guide.InfoWrite("Occurrence: " & occName & " ; ")
        Guide.InfoWrite("Owning component: " & obj.OwningComponent.Name & " ; ")
        Guide.InfoWriteLine("Prototype: " & protoName)
    End If
Loop
```

Since this code is only examining objects of type NXOpen.Body, you may be wondering why we didn't simply cycle through the workPart.Bodies collection. This would be simpler because we wouldn't have to concern ourselves with tags. However, if you cycle through workPart.Bodies, you won't find bodies that are occurrences, you will only find the ones that are embedded in the work part.

If you run the code above with Axle\_Assembly.prt as your work part, the output will be as follows:

```
Occurrence: RIGHT_TIRE_BODY ; Owning component: RIGHT-WHEEL ; Prototype: TIRE_BODY
Occurrence: RIGHT_RIM_BODY ; Owning component: RIGHT-WHEEL ; Prototype: RIM_BODY
Occurrence: LEFT_TIRE_BODY ; Owning component: LEFT-WHEEL ; Prototype: TIRE_BODY
Occurrence: LEFT_RIM_BODY ; Owning component: LEFT-WHEEL ; Prototype: RIM_BODY
```

There is a distinction between temporary and permanent object occurrences. Most object occurrences are temporary, they are used by NX's display and selection systems, but they are not stored permanently in the part file when it is saved. This avoids bloating the file unnecessarily. However, if an occurrence is referenced by another permanent object, then it must become permanent itself. For example, if you attach a drawing note to an occurrence of a solid body, then the solid body's occurrence will become permanent.

Permanent object occurrences will be discussed further in the "Reference Sets" section.

## ■ Creating an Assembly

The most common way to create an assembly is to insert parts as components into a parent assembly file. We will use this technique to create the assembly shown below. It is a simple circular door assembly, as you might find in a submarine or space ship, consisting of a circular plate with a "grip" or handle located at its center.

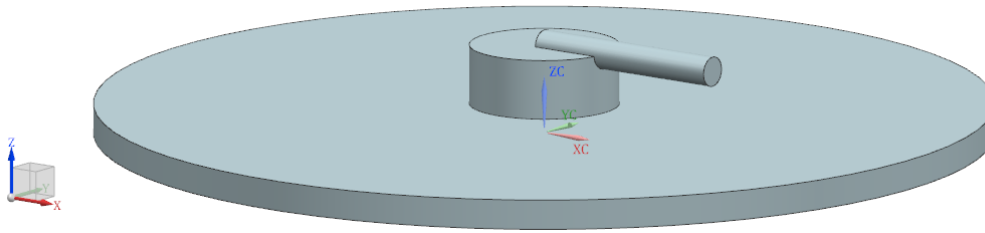

In the folder [...NX]\UGOPEN\NXOpenExamples\ExampleParts, you will find two part files called door.prt and grip.prt that we will use to create the assembly.

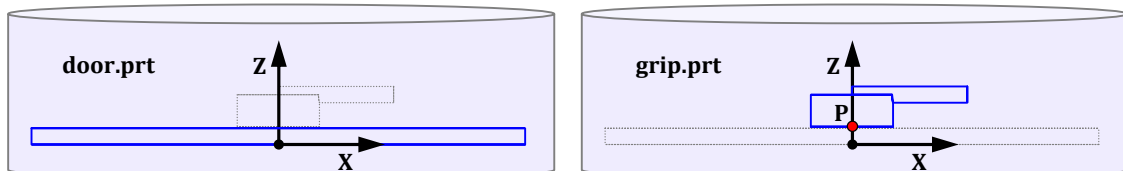

The point P where the base of the handle is located (the red point) has coordinates (0,0,1).

Combining these two parts to form the assembly shown above is very easy because the “door” and “grip” objects are already located correctly in space. This is not an unusual situation — quite a few companies design components in “absolute position” so that no further positioning is required when they are assembled into products. So, to create a new assembly file and add these two parts to it, we proceed as follows:

```
' Create a new assembly file, and make it the work part
Dim mm As NXOpen.Part.Units = NXOpen.Part.Units.Millimeters
Dim doorAssy As NXOpen.Part = session.Parts.NewDisplay("C:\Temp\doorAssy.prt", mm)
session.Parts.SetWork(doorAssy)

Dim compAssy As NXOpen.Assemblies.ComponentAssembly = doorAssy.ComponentAssembly
Dim status As PartLoadStatus = Nothing
Dim origin As New NXOpen.Point3d(0,0,0)
Dim layers As Integer = -1

' Create an identity matrix to use for orientation
Dim matrix As new NXOpen.Matrix3x3
matrix.Xx = 1 : matrix.Xy = 0 : matrix.Xz = 0
matrix.Yx = 0 : matrix.Yy = 1 : matrix.Yz = 0
matrix.Zx = 0 : matrix.Zy = 0 : matrix.Zz = 1

' Add the two parts to the assembly
Dim refSetName = "MODEL"
Dim partFilePath = "C:\Temp\door.prt"
Dim compName As String = "doorComp"
compAssy.AddComponent(partFilePath, refSetName, compName, origin, matrix, layers, status)

partFilePath = "C:\Temp\grip.prt"
compName = "gripComp"
compAssy.AddComponent(partFilePath, refSetName, compName, origin, matrix, layers, status)
```

The code assumes that two files door.prt and grip.prt are in your C:\Temp folder. You can either put them there, or you can change the code to use different path names. The real work is done by the call to the [AddComponent](#) function. The meanings of its various arguments are as follows:

Argument	Data Type	Description
<code>partFilePath</code>	String	The pathname of the part file to be inserted as a new component
<code>refSetName</code>	String	The name of the reference set to be used to represent the new component
<code>compName</code>	String	The name to be assigned to the new component
<code>origin</code>	Point3d	The location where the new component is to be placed
<code>matrix</code>	Matrix3x3	The orientation to be used for the new component within the assembly
<code>layers</code>	Integer	The layer(s) on which the component's member objects should be placed
<code>status</code>	PartLoadStatus	A status data structure that indicates whether the insertion was successful

Reference sets provide a way to use simplified representations of components in assemblies, which can improve performance and reduce memory usage. You can read about these in the “Assemblies” section of the NX documentation. You can either create your own custom reference sets, or you can use the standard ones that NX creates for you automatically. The names of the standard ones are “MODEL”, “Entire Part”, and “Empty”. A little later, we will tell you how to write code that replaces one reference set by another.

The `origin` and `matrix` arguments specify the position and orientation of the component part in the assembly, as described earlier in the section entitled “[Component Positions & Orientations](#)”. In the example above, the positioning and orientation logic was rather dull because the parts were already in the correct locations and did not need to be moved; a more interesting example is given below.

The `layers` argument indicates the destination layers on which the component itself and its members (occurrence objects) should be placed. The meanings of the available settings are as follows:

Value	Destination Layer for Component	Destination Layer for Component Members
<code>layers = 0</code>	Work layer	Work layer
<code>layers = -1</code>	Work layer	Original layers (layers of prototype objects)
<code>layers = n</code>	Layer n	Layer n

## ■ More Advanced Positioning

Suppose now that we want to design a door with two grips, a “top” grip at the “12 o’clock” location, and a “right” grip at “3 o’clock”, as shown here:

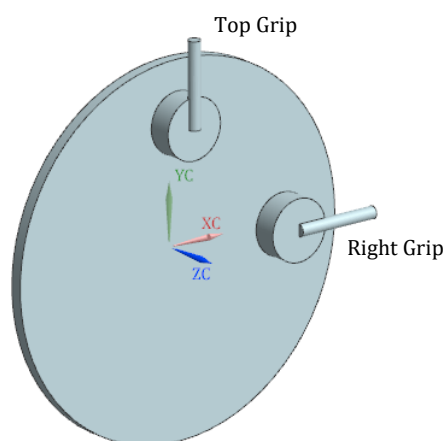

We create a new assembly part and insert the door component into it, just as before. Next, we have to position and orient the two handles as shown below:

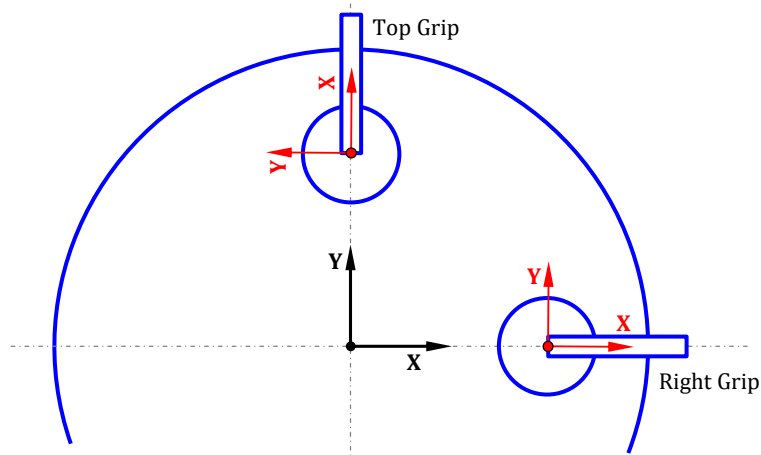

The Right Grip is easy, because it just needs to be translated, not rotated. The code is as follows:

```
Dim path = "C:\Temp\grip.prt"
Dim refSetName = "MODEL"
Dim status As PartLoadStatus = Nothing
Dim layers As Integer = -1

' Define the orientation for the RightGrip (identity)
Dim matrix1 As new NXOpen.Matrix3x3
matrix1.Xx = 1 : matrix1.Xy = 0 : matrix1.Xz = 0
matrix1.Yx = 0 : matrix1.Yy = 1 : matrix1.Yz = 0
matrix1.Zx = 0 : matrix1.Zy = 0 : matrix1.Zz = 1

' Define the location for RightGrip
Dim pt1 As New NXOpen.Point3d(10, 0, 0)

' Add RightGrip to the assembly
Dim compName1 As String = "rightGripComp"
Dim rightGrip As NXOpen.Assemblies.Component
rightGrip = compAssy.AddComponent(path, refSetName, compName1, pt1, matrix1, layers, status)
```

Since no rotation is needed, the matrix used is just the identity. The only new idea here is the use of the point  $pt1 = (10,0,0)$  to position the component. Note that we used the point  $(10,0,0)$ , not  $(10,0,1)$  because an offset of 1 mm in the z-direction is already built into the design in grip.prt.

The positioning of TopGrip is a little more interesting. The code is:

```
' Define the orientation for the TopGrip
Dim matrix2 As new NXOpen.Matrix3x3
matrix2.Xx = 0 : matrix2.Xy = 1 : matrix2.Xz = 0 ' Grip's X-axis is aligned with ( 0,1,0)
matrix2.Yx = -1 : matrix2.Yy = 0 : matrix2.Yz = 0 ' Grip's Y-axis is aligned with (-1,0,0)
matrix2.Zx = 0 : matrix2.Zy = 0 : matrix2.Zz = 1 ' Grip's Z-axis is aligned with ( 0,0,1)

' Define the location for the TopGrip
Dim pt2 As New NXOpen.Point3d(0, 10, 0)

' Add TopGrip to the assembly
Dim compName2 As String = "topGripComp"
Dim topGrip As NXOpen.Assemblies.Component
topGrip = compAssy.AddComponent(path, refSetName, compName2, pt2, matrix2, layers, status)
```

We want the grip's x-axis to be aligned with the vector  $(0,1,0)$  in the assembly part, so we set  $(Xx, Xy, Xz) = (0,1,0)$  in the definition of `matrix2`. The other two rows of the matrix are defined using similar reasoning.



## ■ Reference Sets

It's not really necessary here, but there are times when you may want to use simplified representation of components in your assemblies, to save memory and improve performance. One way to do this is through the use of reference sets. The file grip.prt includes a reference set called "WIRE" that represents the grip shape just by using two lines. We can swap out the "MODEL" reference set that we used above and use "WIRE" instead. The code to perform this replacement in both grip components is:

```
doorAssy.ComponentAssembly.ReplaceReferenceSet(rightGrip, "WIRE")
doorAssy.ComponentAssembly.ReplaceReferenceSet( topGrip, "WIRE")
```

The result is as shown here:

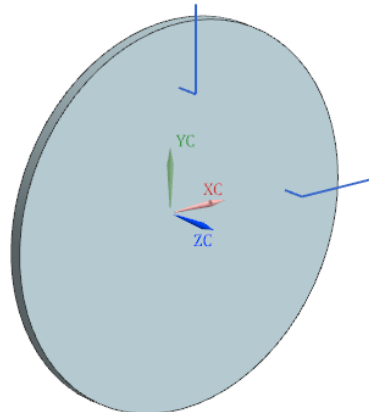

In the previous section "Object Occurrences", we mentioned that for each part occurrence (component), the system will create object occurrences of some of the objects inside that part. Reference sets are the key to this. Each component has a current reference set (shown in the "Reference Set" column in the Assembly Navigator). So for each component, NX creates temporary object occurrences of *precisely* those objects which are members of the component's current reference set.

In the example above (grip.prt), the "WIRE" reference set contains two lines, and does not contain the solid body. Whereas the "MODEL" reference set contains the solid body but not the two lines. When you change the grip component's reference set from "MODEL" to "WIRE", the system deletes the object occurrence of the solid body, and creates object occurrences of the two lines.

Also in the section "Object Occurrences" we discussed permanent vs. temporary object occurrences. Permanent object occurrences continue to exist even if you change to a refset that does not contain the prototype object. However the occurrence will no longer be displayed in that case.

To continue the example from above, suppose you attach a drawing note to the grip component's object occurrence of the solid body. This will make the solid body occurrence permanent. Then, if you subsequently change the component's reference set to "WIRE", the solid body occurrence is hidden from the display, but it is *not* deleted.

Some NXOpen methods are capable of creating occurrences even if they "should not" exist according to the reference set. `NXOpen.Assemblies.Component.FindOccurrence` is one such method. This method, given a component and an object in that component's prototype part, locates the corresponding object occurrence. If no object occurrence exists, because the prototype object is not in the component's current reference set, `FindOccurrence` will create a permanent object occurrence (and hide it from the display).

In contrast, the methods `NXOpen.UF.UFAssem.CycleObjsInComp` and `NXOpen.UF.UFAssem.CycleEntsInPartOcc` will locate only the *existing* object occurrences owned by a component. Note that these methods will return any permanent object occurrences that exist, regardless of whether they are currently displayed or hidden.

## ■ Other Topics

NX Open has a very rich and complex collection of functions for working with assemblies. After reading the material in this chapter, you should be ready to start using these functions. In addition to the functions in the `NXOpen.Assemblies` namespace, which we have used here, there are older functions in the `NXOpen.UF.UFAssem`

class, along with several example programs, and some useful explanatory notes. One large topic that we have omitted here is the use of “constraints” to position components in an assembly; to learn more about this, please refer to the [NXOpen.Positioning](#) namespace in the NX Open Reference Guide.

# Chapter 12: Drawings & Annotations

This chapter discusses NX Open functions for working with drawings and annotations.

## ■ Drawings

In NX Open, functions related to drawings can be found in the `NXOpen.Drawings` namespace, and in the `NXOpen.UF.UFDraw` class. Note that the documentation for the `NXOpen.UF.UFDraw` class contains many sample programs. While these are written in the C language, conversion to other languages is typically straightforward.

A drawing is represented by a collection of `NXOpen.Drawings.DrawSheet` objects in NX Open. The set of all `DrawingSheet` objects in the work part (or any part file) is a `DrawingSheetCollection` object, which you can get by using the `workPart.DrawingSheets` property.

Each sheet has a `SheetDraftingViewCollection` object, which is important because you use it to work with the views on the sheet (to create and delete views, for example). You can get this object by using the `SheetDraftingViews` property of the sheet. Some typical operations are as follows:

Code	Description
<code>sheets = workPart.DrawingSheets</code> <code>sheets.InsertSheet( )</code>	Create a drawing sheet
<code>myDrawing.Delete( )</code>	Delete a drawing sheet
<code>views = mySheet.SheetDraftingViews</code> <code>views.CreateBaseView( )</code> <code>views.CreateProjectedView( )</code>	Add a view to a drawing sheet
<code>views = mySheet.SheetDraftingViews</code> <code>views.DeleteView( )</code>	Remove a view from a drawing sheet
<code>sheets = workPart.DrawingSheets</code> <code>dwg = sheets.CurrentDrawingSheet</code>	Get the current drawing (sheet)
<code>dwg.Open( )</code>	Set the current drawing (sheet)
<code>dwg.GetDraftingViews( )</code>	Get the views of a drawing sheet

Here is a fragment of typical code:

```
' Get the current drawing (sheet)
Dim sheets As NXOpen.Drawings.DrawingSheetCollection = workPart.DrawingSheets
Dim workSheet As NXOpen.Drawings.DrawingSheet = sheets.CurrentDrawingSheet

' Get the array of views on the current sheet
Dim viewArray As NXOpen.Drawings.DrawingView() = workSheet.GetDraftingViews

' Get the SheetDraftingViewCollection of the current view
Dim viewCollection As NXOpen.Drawings.SheetDraftingViewCollection = workSheet.SheetDraftingViews

' Delete all the views on the current sheet
For Each View As NXOpen.Drawings.DrawingView In viewArray
    viewCollection.DeleteView(view)
Next
```

## ■ Dimensions

To create dimensions in a part, you use functions in its `DimensionCollection` object, which you can obtain by using the `Dimensions` property of the part. Simple dimensions can be created directly; more complex ones are created indirectly using the “builder” pattern that we have seen elsewhere in NX Open. Here are some of the more common functions for creating dimensions (either directly or via builders):

Use These Functions	To Create
<a href="#">CreateHorizontalDimension( )</a> <a href="#">CreateVerticalDimension( )</a> <a href="#">CreateLinearDimensionBuilder( )</a>	Horizontal or vertical dimension
<a href="#">CreateParallelDimension( )</a>	Parallel dimension
<a href="#">CreatePerpendicularDimension( )</a>	Perpendicular dimension
<a href="#">CreateAngularDimensionBuilder( )</a> <a href="#">CreateMajorAngularDimension( )</a> <a href="#">CreateMajorAngularDimensionBuilder( )</a> <a href="#">CreateMinorAngularDimension( )</a> <a href="#">CreateMinorAngularDimensionBuilder( )</a>	Angular dimension
<a href="#">CreateArcLengthDimension( )</a> <a href="#">CreateCurveLengthDimensionBuilder( )</a>	Arc length dimension
<a href="#">CreateCylindricalDimension( )</a>	Cylindrical dimension
<a href="#">CreateRadiusDimension( )</a>	Radius dimension
<a href="#">CreateFoldedRadiusDimension( )</a>	Folded radius dimension
<a href="#">CreateDiameterDimension( )</a>	Diameter dimension
<a href="#">CreateHoleDimension( )</a>	Hole dimension
<a href="#">CreateConcentricCircleDimension( )</a>	Concentric circle dimension
<a href="#">CreateHorizontalOrdinateDimension( )</a> <a href="#">CreateVerticalOrdinateDimension( )</a> <a href="#">CreateOrdinateDimensionBuilder( )</a>	Ordinate dimension

Here is some code to create an arc length dimension directly:

```
Dim myArc As NXOpen.Arc = Snap.Create.Arc( {0,0,0}, 450, 0, 90 )

Dim assoc As NXOpen.Annotations.Associativity = workPart.Annotations.NewAssociativity

assoc.FirstObject = myArc
assoc.SecondObject = Nothing
assoc.ObjectView = workPart.Views.WorkView
assoc.PickPoint = New Point3d(350, 650, 0)

Dim dimData As NXOpen.Annotations.DimensionData = workPart.Annotations.NewDimensionData
dimData.SetAssociativity(1, {assoc})
assoc.Dispose

Dim origin As New Point3d(370, 670, 0)

Dim arcLengthDim As NXOpen.Annotations.ArcLengthDimension
arcLengthDim = workPart.Dimensions.CreateArcLengthDimension(dimData, origin)
```

Next, here's how you do the same thing by using a builder, instead:

```
Dim builder As Annotations.CurveLengthDimensionBuilder
builder = workPart.Dimensions.CreateCurveLengthDimensionBuilder(Nothing)

builder.Origin.Anchor = Annotations.OriginBuilder.AlignmentPosition.MidCenter
builder.Origin.Origin.SetValue(Nothing, Nothing, New Point3d(370, 670, 0))
builder.Origin.SetInferRelativeToGeometry(True)

Dim pickPoint As New Point3d(350, 650, 0)
builder.FirstAssociativity.SetValue(myArc, workPart.Views.WorkView, pickPoint)

Dim arcLengthDim As NXOpen.Annotations.ArcLengthDimension
arcLengthDim = builder.Commit
builder.Destroy
```

ArcLength dimensions are not very common, of course, so this might seem like a strange example to choose. We chose it because arcLength dimensions can easily be created either directly or by using a builder, so we could illustrate both approaches. The direct creation functions might appear simpler, but the builder approach provides much more flexibility, so it's worth spending a bit of extra time to become familiar with it.

## ■ Notes

To create a Note, typical code is:

```
Dim mgr As NXOpen.Annotations.AnnotationManager = workPart.Annotations
mgr.CreateNote(...)
```

# Chapter 13: CAM

This chapter provides a brief introduction to NX Open functions related to CAM.

To gain access to CAM capabilities, you first obtain an `NXOpen.CAM.CAMSetup` object. There will be a `CAMSetup` object in every part file that you use for CAM work, and typical code to obtain it (for the work part) is as follows:

```
Dim workPart As Part = NXOpen.Session.GetSession.Parts.Work
Dim setup As NXOpen.CAM.CAMSetup = workPart.CAMSetup
```

## ■ Cycling Through CAM Objects

Cycling through CAM objects is supported by two properties of the `CAMSetup` object, called `CAMOperationCollection` and `CAMGroupCollection`. These are completely analogous to the other object collections, like the `workPart.Points` or `workPart.Bodies` collections that let you cycle through points or bodies respectively. They have other uses, too, but we'll get to those later.

The `CAMOperationCollection` property gives you an `NXOpen.CAM.OperationCollection` object, which is a collection of `NXOpen.CAM.Operation` objects. These operations will actually have more specific types, such as `MillOperation`, `TurningOperation`, `InspectionOperation`, `HoleMaking`, and so on. The collection is enumerable, so you can cycle through the operations using a `For Each` loop, like this:

```
Dim setup As NXOpen.CAM.CAMSetup = workPart.CAMSetup
Dim opCollection As NXOpen.CAM.OperationCollection = setup.CAMOperationCollection

For Each op As NXOpen.CAM.Operation In opCollection
    Dim opType As System.Type = op.GetType
    Guide.InfoWriteLine(opType.ToString)
Next
```

Similarly, the `CAMGroupCollection` property gives you an `NXOpen.CAM.NCGroupCollection` object, which is a collection of `NXOpen.CAM.NCGroup` objects. Again, you can cycle through the groups using a `For Each` loop. Each `NCGroup` object might actually be a derived type, such as a `FeatureGeometry`, a `Method`, an `OrientGeometry`, or a `Tool`. In the following code, we cycle through looking for `Tool` objects:

```
Dim setup As NXOpen.CAM.CAMSetup = workPart.CAMSetup
Dim groups As NXOpen.CAM.NCGroupCollection = setup.CAMGroupCollection

For Each group As NXOpen.CAM.NCGroup In groups
    If TypeOf(group) Is NXOpen.CAM.Tool Then
        Dim tool As NXOpen.CAM.Tool = DirectCast(group, NXOpen.CAM.Tool)
        Dim toolType As NXOpen.CAM.Tool.Types
        Dim toolSubType As NXOpen.CAM.Tool.Subtypes
        tool.GetTypeAndSubtype(toolType, toolSubType)
        Guide.InfoWriteLine("Tool type: " & toolType.ToString)
        Guide.InfoWriteLine("Tool subtype: " & toolSubType.ToString)
    End If
Next
```

In both cycling examples, note how we used the standard VB functions `GetType` and `TypeOf` to get and test the type of an operation or an `NCGroup`.

The types and subtypes of tools are handled in a different fashion. As the code above shows, there is a `GetTypeAndSubtype` function, which returns values from two enumerations, `CAM.Tool.Types` and `CAM.Tool.Subtypes`.

## ■ Editing CAM Objects

For editing, CAM objects use the same sort of “builder” approach as modeling features and other objects. So the basic steps are to create a “builder” object, modify its properties, and then “commit” the changes. The pattern is shown in the following code:

```
Dim setup As NXOpen.CAM.CAMSetup = workPart.CAMSetup
Dim opCollection As NXOpen.CAM.OperationCollection = setup.CAMOperationCollection

For Each op As NXOpen.CAM.Operation In opCollection
    If TypeOf(op) Is NXOpen.CAM.HoleDrilling Then
        Dim drillop As CAM.HoleDrilling = CType(op, CAM.HoleDrilling)
        Dim builder As CAM.HoleDrillingBuilder = opCollection.CreateHoleDrillingBuilder(drillop)
        builder.CollisionCheck = True
        builder.Commit
    End If
Next
```

As you can see, the code turns on collision checking for all hole-drilling operations. For each operation, it creates a builder, sets its `CollisionCheck` property to `True`, and then commits the builder to effect the change. To use this approach, you have to know where to find the functions that create builders for various types of CAM objects (like the `CreateHoleDrillingBuilder` function we used above). They can be found in two places. First, the `NXOpen.CAM.OperationCollection` class contains functions that create builders for operations:

Function	Creates a builder for
<code>CreateCavityMillingBuilder</code>	A planar milling cavity operation
<code>CreateCenterlineDrillTurningBuilder</code>	A centerline drill turning operation
<code>CreateEngravingBuilder</code>	A planar milling text operation
<code>CreateFaceMillingBuilder</code>	A planar milling facing operation
<code>CreateHoleDrillingBuilder</code>	A hole drilling operation
<code>CreatePlanarMillingBuilder</code>	A planar milling planar operation

Secondly, the `NXOpen.CAM.NCGroupCollection` class contains functions that create builders for various types of CAM “groups”, which include tools, CAM geometry, and machining methods:

Function	Creates a builder for
<code>CreateBarrelToolBuilder</code>	A barrel tool
<code>CreateDrillGeomBuilder</code>	A drill geometry
<code>CreateDrillMethodBuilder</code>	A drill method
<code>CreateDrillTapToolBuilder</code>	A drill tap tool
<code>CreateMachineTurretGroupBuilder</code>	A machine turret group
<code>CreateMillToolBuilder</code>	A mill tool
<code>CreateMillGeomBuilder</code>	A mill geometry
<code>CreateProgramOrderGroupBuilder</code>	A program order group

Here is another example, this time editing tool objects:

```

Dim setup As NXOpen.CAM.CAMSetup = workPart.CAMSetup
Dim groups As NXOpen.CAM.NCGroupCollection = setup.CAMGroupCollection

For Each group As NXOpen.CAM.NCGroup In groups
  If TypeOf(group) Is NXOpen.CAM.Tool Then
    Dim toolType As NXOpen.CAM.Tool.Types
    Dim toolSubType As NXOpen.CAM.Tool.Subtypes
    tool.GetTypeAndSubtype(toolType, toolSubType)
    If toolType = CAM.Tool.Types.Mill
      Dim builder As NXOpen.CAM.MillingToolBuilder = groups.CreateMillToolBuilder(tool)
      builder.CoolantThrough = True
      builder.Commit
    End If
  End If
Next Next

```

As you can see, the code sets `CoolantThrough = True` for every milling tool.

## ■ CAM Views

Within a given setup, the NCGroup and Operation objects are arranged hierarchically. There are actually four independent tree structures: the Geometry view, the MachineMethod view, the MachineTool view, and the ProgramOrder view, which correspond with the four possible views shown in the Operation Navigator in interactive NX:

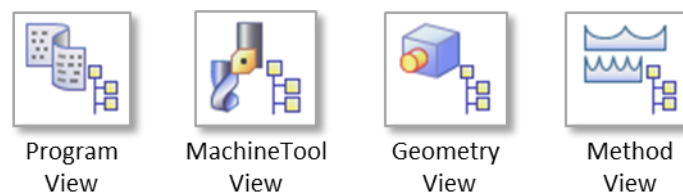

Any given operation will appear in all four of these views. As the name implies, the four views just provide us with four different ways of looking at the same set of operations. In NX Open, the four view types are described by the four values of the `NXOpen.CAM.CAMSetup.View` enumeration. An `NCGroup` object has `GetParent` and `GetMembers` functions, so we can navigate up and down each tree. An `Operation` object has a `GetParent` function that tells us its parent in **each** of the four views. There is also a `GetRoot` function that gives us the root of each view tree.

So, the code to get the root of each view and the first-level members is as follows:

```

Dim setup As NXOpen.CAM.CAMSetup = workPart.CAMSetup

Dim geometryRoot As NXOpen.CAM.NCGroup = setup.GetRoot(NXOpen.CAM.CAMSetup.View.Geometry)
Dim methodRoot As NXOpen.CAM.NCGroup = setup.GetRoot(NXOpen.CAM.CAMSetup.View.MachineMethod)
Dim machineRoot As NXOpen.CAM.NCGroup = setup.GetRoot(NXOpen.CAM.CAMSetup.View.MachineTool)
Dim programRoot As NXOpen.CAM.NCGroup = setup.GetRoot(NXOpen.CAM.CAMSetup.View.ProgramOrder)

Dim geometryRootMembers As NXOpen.CAM.CAMObject() = geometryRoot.GetMembers
Dim methodRootMembers As NXOpen.CAM.CAMObject() = methodRoot.GetMembers
Dim machineRootMembers As NXOpen.CAM.CAMObject() = machineRoot.GetMembers
Dim programRootMembers As NXOpen.CAM.CAMObject() = programRoot.GetMembers

```

When we create a new “group” object (like a tool), it must be correctly placed in one of these four views, by indicating which group should be its parent. When we create an operation object, it must be correctly placed in all four views, so we need to specify four parents. Further details can be found in the next section, which discusses creation of tools.



## ■ Creating a Tool

The NX Open process for creating a tool involves several steps. The basic code begins with something like the following:

```
Dim setup As NXOpen.CAM.CAMSetup = workPart.CAMSetup
Dim groups As NXOpen.CAM.NCGroupCollection = setup.CAMGroupCollection
Dim machineRoot As NXOpen.CAM.NCGroup = setup.GetRoot(NXOpen.CAM.CAMSetup.View.MachineTool)

Dim camFalse As CAM.NCGroupCollection.UseDefaultName = CAM.NCGroupCollection.UseDefaultName.False

Dim toolGroup As CAM.NCGroup
toolGroup = groupCollection.CreateTool(machineRoot, "mill_planar", "BALL_MILL", camFalse, "T24")
Dim myTool As CAM.Tool = CType(toolGroup, CAM.Tool)
```

The definition of `camFalse` is not important; it's only purpose is to avoid writing a very long line of code later on. The most important function shown is `CreateTool` which (not surprisingly) creates a tool object. The first parameter indicates which group should be the parent of the new tool; by specifying the `machineRoot` group, we are indicating that the new tool should be placed at the top level of the `MachineTool` view hierarchy.

The “`mill_planar`” and “`BALL_MILL`” strings indicate the tool type and subtype respectively. These are the same strings that appear in the Insert Tool dialog in interactive NX. Some example values for this pair of strings are:

Tool Type	Tool Subtype
<code>mill_planar</code>	<code>MILL</code>
<code>mill_planar</code>	<code>CHAMFER_MILL</code>
<code>mill_planar</code>	<code>BALL_MILL</code>
<code>mill_planar</code>	<code>SPHERICAL_MILL</code>
<code>mill_planar</code>	<code>T_CUTTER</code>
<code>mill_planar</code>	<code>BARREL</code>
<code>hole_making</code>	<code>COUNTER_SINK</code>
<code>hole_making</code>	<code>COUNTER_BORE</code>
<code>drill</code>	<code>COUNTERSINKING_TOOL</code>
<code>drill</code>	<code>COUNTERBORING_TOOL</code>

Our next task is to specify specific values for various tool parameters like diameter and length. Since we have not yet provided these values, our tool is just a generic “default” one. Continuing from above, the necessary code is:

```
Dim toolBuilder As CAM.MillToolBuilder = groupCollection.CreateMillToolBuilder(myTool)

toolBuilder.TlDiameterBuilder.Value = 4.5
toolBuilder.TlHeightBuilder.Value = 15
toolBuilder.TlNumFlutesBuilder.Value = 4
toolBuilder.Description = "Example ball mill"
toolBuilder.HelicalDiameter.Value = 80.0

toolBuilder.Commit

toolBuilder.Destroy
```

The pattern should be familiar, by now: we create a builder, modify its values, and then commit and destroy. This is essentially the same editing process that we used in an earlier example. The only difference here is that we had to create a default tool before we started the editing process.

# Chapter 14: Block-Based Dialogs

Since around 2007, the NX user interface has been based on “block-based” dialogs, so-called because they are built from a common collection of user interface “blocks”. So, for example, this dialog consists of four blocks, whose types are indicated by the labels to the right

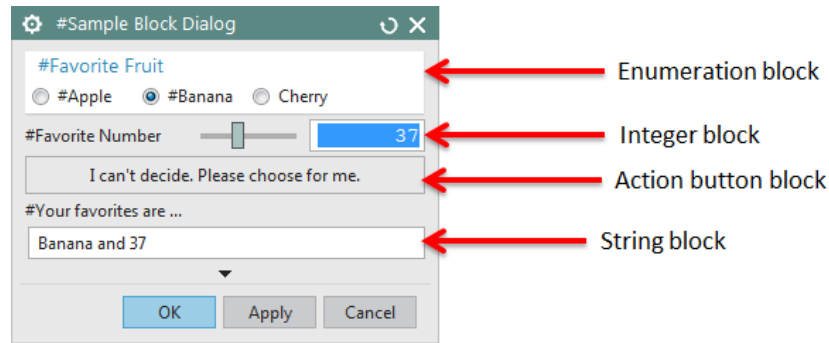

Each block has a specific type and purpose. So, looking at the four examples from the dialog above:

- An Enumeration block presents a set of options to the user, and asks him to choose one of them
- An Integer block allows the user to enter an integer (by typing, or by using a slider, for example)
- An Action Button block performs some action when the user clicks on it
- A String block displays text that the user can (sometimes) edit

Blocks of any given type are used in many different dialogs throughout NX. Application developers build dialogs from blocks, rather than from lower-level items. This reduces programming effort for NX developers, and guarantees consistency. Constructing a new Enumeration block (for example) requires very little code, and this new Enumeration block is guaranteed to look and behave in exactly the same way as all other Enumeration blocks within NX.

You can construct these same “block-based” dialogs in NX Open, so your add-on applications can look and behave like the rest of NX. This chapter tells you how to do this. We will show you how to use Block UI Styler to design your dialog. After your dialog is designed, we will show you how to make it function by adding code to the dialog callbacks.

## ■ When to Use Block-Based Dialogs

As we saw earlier, you can use Windows Forms (WinForms) to create dialogs for your NX Open applications, and Visual Studio has some very nice tools to help you do this. So, you may be wondering why you should use block-based dialogs instead. WinForm dialogs are very rich and flexible, so there may be times when they are appropriate. On the other hand, block-based dialogs are rigid and highly structured, because they enforce NX user interface standards. Unless the added flexibility of a WinForm brings some significant benefit, it's better to have a block-based dialog whose appearance and behavior are consistent with the rest of NX. Also, achieving NX-like behavior in a WinForm-based dialog sometimes requires a great deal of work. This is especially true of dialogs that have accompanying graphical feedback (like Selection and the Point, Vector and Plane Subfunctions). For these kinds of situations, implementation using blocks is usually much easier. So, in short, we recommend using block-based dialogs unless the added flexibility of WinForms provides some large benefit that outweighs the drawbacks of inconsistency and increased development cost.

## ■ How Block-Based Dialogs Work

The diagram below shows how your code interacts with a block-based dialog

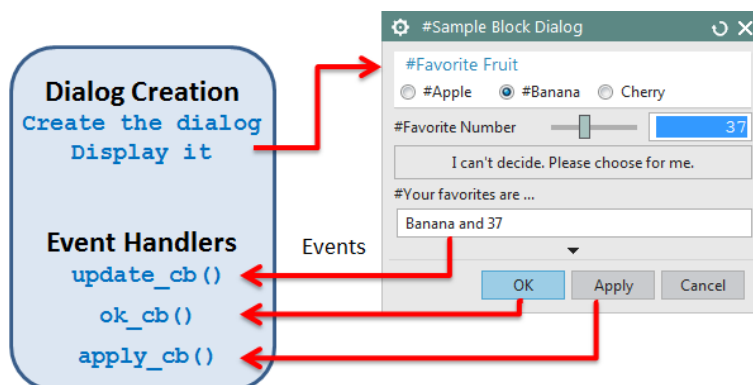

First, your code creates and displays the dialog. Then, when the user starts to interact with the dialog, NX sends messages back to your code, telling you what “events” occurred in the dialog. For example, NX might tell you that the user entered some number, or clicked on the Apply button. Your code should have functions called “event handlers” or “callbacks” that determine what should happen (if anything) in response to each event. The code generator for Block UI Styler can create template functions for these event handlers. The dialog constructor contains code to register the event handlers for specific dialog events, so that NX knows which event handler to call for a particular dialog event; for example, we might stipulate that NX should call an event handler named “apply\_cb” when the user clicks the Apply button. If you want to create some geometry when the user clicks the Apply button, you would put the code to create this geometry in your `apply_cb` function.

In this chapter, we’ll discuss how to create block-based dialogs. We will use Block UI Styler to define blocks and arrange them on our dialog.

We’ll use an “OrthoLines” example that provides a simple dialog that lets the user create “infinite” lines in the horizontal or vertical directions in the XY-plane.

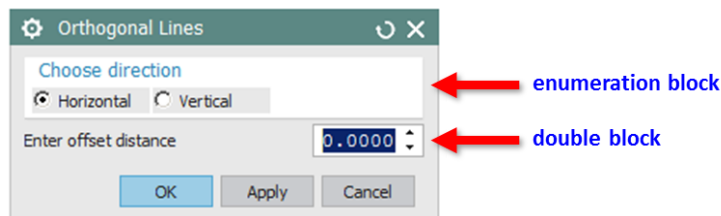

It only has two blocks – an “Enumeration” block to let the user choose either horizontal or vertical, and a “Double” block in which the user enters the offset distance (the distance from the line to the origin).

If you don’t want to create this dialog yourself, using the instructions in this chapter, then you can find a completed version in [\[...NX\]\UGOPEN\NXOpen\Examples\GS Guide\OrthoLines](#).

## ■ The Overall Process

The overall process of developing a BlockDialog is as follows:

- You use Block UI Styler to choose the blocks you want, and arrange them on your dialog
- Block UI Styler creates a “dlx” file, and also some template code
- You edit the template code to define the behavior you want
- At run-time, NX uses the dlx file plus your code to control the appearance and operation of the dialog

The process is illustrated in the following figure, and further details are provided below.

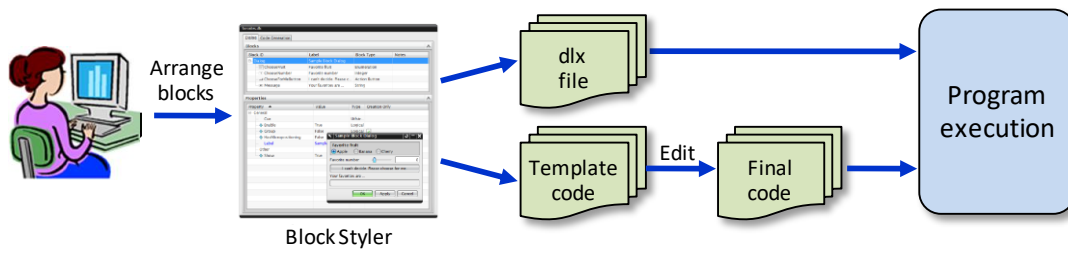

## ■ Using Block UI Styler

Instructions for using Block UI Styler are provided in the NX User Manual, but it is largely self-explanatory. Choosing a block type from the Block Catalog adds a new block to your dialog. You can then adjust its properties as desired. The process is similar to the one for designing WinForms that we saw in chapter 3.

In NX, access Block UI Styler via Start → All Applications → Block UI Styler. We could use Block UI Styler to create the dialog from scratch, but let's just open the file `OrthoLines.dlx` in Block UI Styler, instead — it has the dialog definition already created for you. You can find it in `[...NX]\UGOPEN\NXOpenExamples\VB\GS_Guide\OrthoLines`.

The dialog has two blocks (`directionBlock` and `offsetBlock`), which you will see listed in Block UI Styler:

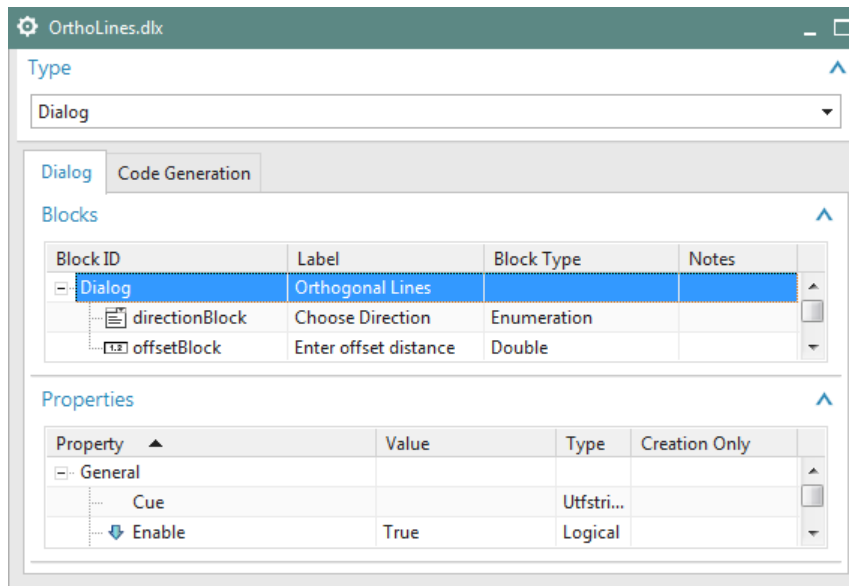

If you click on one of the blocks shown above, its properties will be shown in the lower half of Block UI Styler window, and you can edit them as you wish. Some of the more important properties are shown below:

Block	Property	Value
directionBlock	Block ID	directionBlock
	Label	Choose direction
	PresentationStyle	Radio Box
	Layout	Horizontal
	Value	Horizontal Vertical

Block	Property	Value
offsetBlock	Block ID	offsetBlock
	Label	Enter offset distance
	PresentationStyle	Spin

When you have established all the blocks and properties you want, switch to the Code Generation tab in Block UI Styler, and define the settings as shown below:

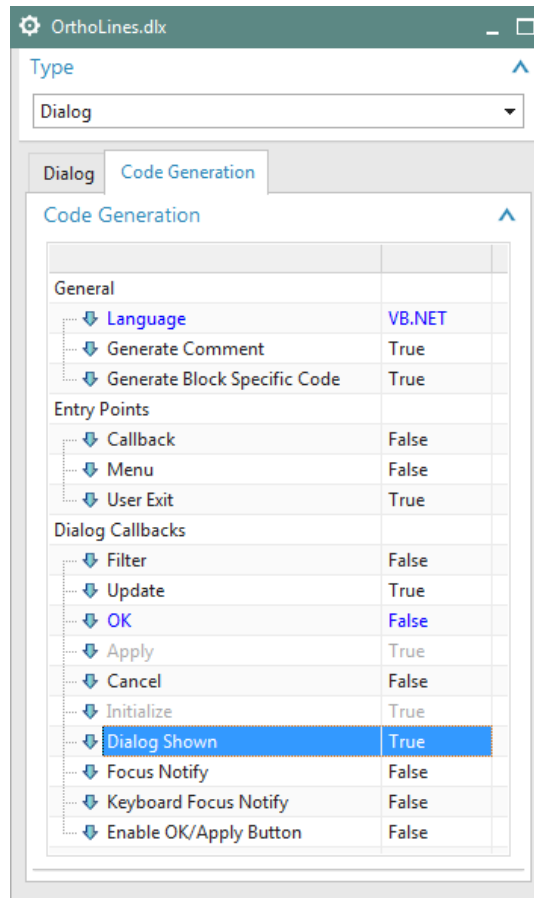

Finally, choose File → Save, which will generate a VB file, called `OrthoLines.vb`, and another file called `OrthoLines.dlx`.

## ■ Template Code

When you save a dialog in Block UI Styler, a Visual Basic file is created containing template code. The idea is that you “fill in the blanks” in this template code to define the way you want your dialog to behave. The contents of the VB file will depend on the options you chose in Block UI Styler.

The code shown below is a bare minimum. We have removed all the error-checking and most of the comments, in order to focus clearly on the essential concepts. In real working code, you should not do this, of course.

When you look at the code in your favorite editor, you will see something like this:

```
Public Class OrthoLines
    'class members
    Private Shared theSession As Session
    Private Shared theUI As UI
    Private theDlxFileName As String
    Private theDialog As NXOpen.BlockStyler.BlockDialog
    Private directionBlock As NXOpen.BlockStyler.Enumeration ' Block type: Enumeration
    Private offsetBlock As NXOpen.BlockStyler.DoubleBlock ' Block type: DoubleBlock
    and so on ...

```

As you can see, we are defining a new class called “OrthoLines” to represent instances of our dialog. Notice that there are two lines that declare variables called `directionBlock` and `offsetBlock` to hold the two blocks that make up an “OrthoLines” dialog.

Then, further down, you will see a constructor (we have removed the Try/Catch blocks to focus on the code):

```
Public Sub New(theDlxFileName As String)
    theSession = Session.GetSession
    theUi = UI.GetUI
    theDlxFileName = "OrthoLines.dlx"
    theDialog = theUI.CreateDialog(theDlxFileName)
    theDialog.AddApplyHandler(AddressOf apply_cb)
    theDialog.AddOkHandler(AddressOf ok_cb)
    theDialog.AddUpdateHandler(AddressOf update_cb)
    theDialog.AddInitializeHandler(AddressOf initialize_cb)
    theDialog.AddDialogShownHandler(AddressOf dialogShown_cb)
End Sub
```

Most of this code is adding “event handler” callbacks to our dialog, as we requested when we saved the dialog from Block UI Styler. You do not need to edit this part of the generated file. You just need to add your code inside the handler functions. This is where we can write code that responds to “events” in the dialog. For example, when the user clicks the “Apply” button in the dialog, the “`apply_cb`” function will be called, so any code we place in that function (see below) will be executed. In this way, we can make the Apply button do something useful when the user clicks it.

Next, let’s look at the sections of the `OrthoLines.vb` file containing the handler functions we are supposed to edit so that our dialog performs the tasks we want. Again, we have removed some error checking code to make the concepts clearer. First, there is the “Main” routine:

```
Public Shared Sub Main()
    theOrthoLines = New OrthoLines()
    theOrthoLines.Show()
    theOrthoLines.Dispose()
End Sub
```

The first two lines are automatically generated code that create a new “OrthoLines” dialog, and display it using the “Show” function. You will usually not need to add any code here unless you have some special setup logic for your dialog that you need to execute before the dialog is constructed.

The most interesting part of a dialog implementation is the code you put in the event handler functions, since this code determines how the dialog will react. When working with `BlockDialog` objects, we normally use the term “callback” rather than “event handler”, but the meaning is the same. In fact, the event handler functions used with `BlockDialog` objects all have the suffix “\_cb” for “Callback” appended to their names.

## ■ The `initialize_cb` and `dialogShown_cb` Event Handlers

Sometimes you want to initialize a block on a dialog to some value or set its appearance before the dialog is shown to the user. The `initialize_cb` and `dialogShown_cb` event handlers allow you to add code that NX will execute before the dialog is shown. The `initialize_cb` is called first, after NX has created the dialog based on the dialog’s `dlx` file. Block UI Styler will use this callback to initialize the helper variables that reference the blocks on your dialog. NX will then initialize the dialog blocks to the values stored in dialog memory. After that, NX will call your `dialogShown_cb` function just before showing the dialog to the user. Any changes you make to the dialog blocks in the `dialogShown_cb` function override the previous settings.

## ■ The `apply_cb` Event Handler

When the user interacts with our dialog, NX will take note of what he does, and send messages back to our code. Specifically, every time the user performs some action in the dialog, NX will call the associated “event handler” function within our code. For example, if the user clicks the “Apply” button, NX will call our `apply_cb` function (since this is the event handler that was registered for an “Apply” event). Whatever code we put inside our `apply_cb` function will then get executed, so we can respond to the “Apply” event in a useful way.

So, let's begin by making the Apply button do something interesting. In the `apply_cb` function, after the comment that says "Enter your callback code here", let's add some code that writes a message to the Info Window:

```
Guide.InfoWriteLine("You clicked the Apply button")
```

Build and run the project. When the dialog appears, click on the Apply button, and this should cause a message to be displayed in the NX Info window. This is not terribly exciting, admittedly, but it shows that the basic mechanism is working — when the user clicks the Apply button, the code in our `apply_cb` function is getting executed.

You should try clicking the OK button, too. You will see that this also causes the same message to appear in the Info window. This is because the default implementation of the `ok_cb` event handler just calls the `apply_cb` function and then closes the dialog. So, our `apply_cb` code is getting executed when the user clicks OK, also.

Of course, what we'd really like to do is create a line when the user clicks the Apply button. Here's a new version of the `apply_cb` function that will do exactly that. Type it in, or copy/paste it, as usual, inside the Try block, after the comment that says "Enter your callback code here":

```
Dim infinity As Double = 50000
Dim d As Double = offsetBlock.Value
If directionBlock.ValueAsString = "Horizontal" Then
    Guide.CreateLine(-infinity, d, 0, infinity, d, 0) ' Create a horizontal line
Else
    Guide.CreateLine(d, -infinity, 0, d, infinity, 0) ' Create a vertical line
End If
```

This code shows the typical pattern of an event handler — you retrieve information from the dialog blocks, and then use this information to do what the user requested. As you can see, we use the `ValueAsString` property of `directionBlock` to decide whether to create a horizontal or vertical line, and we read the offset distance from the `offsetBlock.Value` property. We're assuming that the user has set these values appropriately before clicking the Apply button. The value we're using for `infinity` is arbitrary, of course, and you will probably want to change it to something larger if you design aircraft or ships.

If you build and run this code, you should find that it works nicely. Entering some information and clicking Apply will create a line, as we expect. Clicking OK will also create a line, for the reasons outlined above. Happily, this is exactly what we want.

To make our code a bit cleaner, and to prepare for the steps ahead, let's re-organize a little. For reasons that will become clear later, we're going to package the code that creates an infinite line into a nice tidy function. Copy the following code, and place it somewhere inside the `OrthoLines` class. Right at the bottom, just before the `End Class` line is a good place for it.

```
Private Function CreateLine() As NXOpen.Line
    Dim infinity As Double = 50000
    Dim d As Double = offsetBlock.Value
    If directionBlock.ValueAsString = "Horizontal" Then
        Return Guide.CreateLine(-infinity, d, 0, infinity, d, 0) ' Horizontal line
    Else
        Return Guide.CreateLine(d, -infinity, 0, d, infinity, 0) ' Vertical line
    End If
End Function
```

Note that we have made the function `Private`, since it wouldn't make sense to use it outside the `OrthoLines` class. Now that we have this `CreateLine` function, we can make a much simpler version of our `apply_cb` function, like this (the Try/Catch block has been removed):

```
Public Function apply_cb() As Integer
    CreateLine
    Return 0
End Function
```

The basic version of your OrthoLines function is now complete. Congratulations. In the next section we'll add a little more functionality to it, and learn how to use the `update_cb` function.

## ■ The `update_cb` Event Handler

Suppose we want to create two different kinds of infinite lines — thin dashed ones and thick solid ones. A convenient way to do this would be to place two new buttons on our dialog, like this:

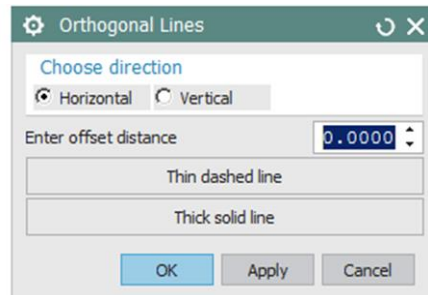

Let's suppose that we're going to call these new buttons `thinDashedButton` and `thickSolidButton`. You can use Block UI Styler to add two buttons to the bottom of your dialog. We have done this for you in the example `OrthoLines2` in `[...NX]\UGOPEN\NXOpenExamples\VB\GS_Guide\OrthoLines2`. If you open the file `OrthoLines2.vb` for this example, you will see two more lines near the top of the file, which declare the variables for the new buttons, like this:

```
Private directionBlock As NXOpen.BlockStyler.Enumeration
Private offsetBlock As NXOpen.BlockStyler.DoubleBlock
Private thinDashedButton As NXOpen.BlockStyler.Button
Private thickSolidButton As NXOpen.BlockStyler.Button
```

Next, the `initialize_cb` function contains code to initialize the variables for the new buttons, where you will see the following two lines:

```
thinDashedButton = CType(theDialog.TopBlock.FindBlock("thinDashedButton"), NXOpen.BlockStyler.Button)
thickSolidButton = CType(theDialog.TopBlock.FindBlock("thickSolidButton"), NXOpen.BlockStyler.Button)
```

You can build the project and run this code, and it should produce the dialog shown above. But, of course, the new buttons won't do anything until we write some event handler code for them.

The event handler code for the two new buttons should go in the `update_cb` function, like this:

```
Public Function update_cb(ByVal block As NXOpen.BlockStyler.UIBlock) As Integer
    Dim myLine As NXOpen.Line

    If block Is thinDashedButton Then
        myLine = CreateLine
        myLine.LineWidth = DisplayableObject.ObjectWidth.Thin
        myLine.LineFont = DisplayableObject.ObjectFont.Dashed
        myLine.RedisplayObject
    End If

    If block Is thickSolidButton Then
        myLine = CreateLine
        myLine.LineWidth = DisplayableObject.ObjectWidth.Thick
        myLine.LineFont = DisplayableObject.ObjectWidth.Solid
        myLine.RedisplayObject
    End If

    Return 0
End Function
```

You can see now why we wrote the `CreateLine` function — because we need to call it in two places in this code. We are creating the lines when we click on either of the new buttons, so you can remove the code in `apply_cb` that we



used in the previous section to create the lines. The dialog should just close when we click on OK. Clicking on Apply will execute the code in the `apply_cb` without closing the dialog. You could modify the dialog so that it only has a Close button, but for now we will just leave the OK and Apply buttons on the dialog.

NX calls our `update_cb` function whenever the user does anything with *any* block on the dialog. As you can see, the `update_cb` function receives a UI block called `block` as input, which tells us which block the user “touched”. We write a series of “if” clauses that test the value of `block`, and do different things in different cases. If we find that `block` has the value `thinDashedButton`, for example, then we know that the user clicked the `thinDashedButton` button, so we create a line that’s thin and dashed.

Of course, it’s possible that the user changed the line direction or the offset distance (rather than clicking one of our two buttons). We could put some more code in the `update_cb` function to handle these events, too, if we wanted. But let’s quit here. Build and run the project, and have some fun making infinite lines.

## ■ Callback Details

We’ve discussed the `update_cb` event handler and the `apply_cb` event handler quite a bit in the last few sections. But some additional event handlers (callbacks) are available, too. The complete list of available callbacks is shown in the Code Generation tab of Block UI Styler, and there you can choose the ones for which you want “stub” code generated. The table below indicates when NX calls each of these:

Callback function name	When NX calls this function
<code>filter_cb</code>	When the user selects an object. It is only used for selection blocks.
<code>update_cb</code>	When the user changes something in the dialog
<code>ok_cb</code>	When the user clicks the OK button
<code>apply_cb</code>	When the user clicks the Apply button
<code>cancel_cb</code>	When the user clicks the Cancel button
<code>initialize_cb</code>	Just before values are loaded from “dialog memory” (see below)
<code>dialogShown_cb</code>	Just before the dialog is displayed (see below)
<code>focusNotify_cb</code>	When focus is shifted to a block that cannot receive keyboard entry
<code>keyboardFocusNotify_cb</code>	When focus is shifted to a block that can receive keyboard entry

The OK, Apply and Cancel callbacks should each return an integer value. In the Cancel callback, this returned value is ignored, so its value doesn’t matter. In the OK and Apply callbacks, returning zero will cause the dialog to be closed, and a positive value will cause it to remain open.

## ■ Precedence of Values

In many situations, the values the user enters into a dialog are stored internally within NX, so that they can be reloaded and used as default values the next time the dialog is displayed. You may have noticed this happening in the example above. This facility is called “dialog memory”. If your code is trying to control the contents of a dialog, it is important to understand how this reloading from dialog memory fits into the overall process. The chain of events is as follows:

- (1) Values and options from the corresponding `dlx` file are used, then ...
- (2) Values and options specified in the `initialize_cb` function are applied, and then ...
- (3) Values from dialog memory are applied, and then ...
- (4) Values and options specified in the `dialogShown_cb` function are applied, and then finally ...
- (5) The dialog is displayed

So, you can see that values and options you set in the `initialize_cb` function might get overwritten by values from dialog memory. Since the `dialogShown_cb` function is executed later, it does not suffer from this drawback. On the other hand, the `initialize_cb` function can set values that the `dialogShown_cb` function cannot. So, in short, the `initialize_cb` function gives you broader powers, but the `dialogShown_cb` function gives you stronger ones.

## ■ Getting More Information

This is a very simple example, of course. In more realistic cases, there will likely be much more code, but the basic structure will remain the same. The standard NX documentation set includes a manual describing the details of Block UI Styler. Also, the NXOpen samples folder contains eight examples of Block UI Styler dialogs. Its location is typically [...NX]\UGOPEN\SampleNXOpenApplications\NET\BlockStyler. The dialog elements used in Block UI Styler dialogs are documented in the `NXOpen.BlockStyler` namespace section of the NX Open .NET API Reference Manual.

# Chapter 15: Selecting NX Objects

In order to perform some operation on an NX object, the user will often have to select it, first. So, we need some way to support selection in our NX Open programs. You can use either a free-standing `Selection` object or a `SelectObject` block on a block-based dialog. The two approaches have much in common, and this chapter describes both of them.

## ■ Selection Dialogs

One way to support selection in NX Open is to use the tools in the `NXOpen.Selection` class. The general process is:

- You get the `Selection` object from the `NXOpen.UI`
- You define some variables for the selection parameters, if necessary
- You call one of the selection methods on it, so that it can gather information from the user
- A `Selection.Response` is returned to you, as well as the selected objects if the user did not cancel the selection

Here is a short snippet of code illustrating this process. Note that we wrote `Imports NXOpen.Selection` at the top to make the code simpler:

```
Imports NXOpen.Selection
...
Dim theUI = UI.GetUI
Dim selManager = theUI.SelectionManager
Dim obj As TaggedObject
Dim cursor As Point3d
Dim cue = "Please select a curve to be hidden"
Dim title = "Selection Demo"
Dim scope = SelectionScope.AnyInAssembly
Dim action = SelectionAction.ClearAndEnableSpecific
Dim highlight = False
Dim types As SelectionType() = { SelectionType.Curves }

Dim response = selManager.SelectTaggedObject(cue, title, scope, highlight, types, obj, cursor)

If response <> Response.Cancel And response <> Response.Back Then
    Dim dispObj = CType(obj, DisplayableObject)
    dispObj.Blank
End If
```

When the code shown above is executed, a small dialog appears giving the user the opportunity to select a curve.

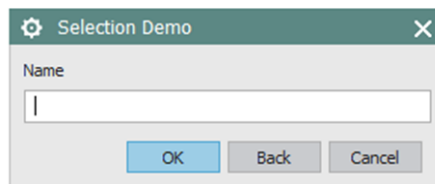

If the user selects a curve and clicks OK, the selected curve will be returned to your code in the `selectedObject` variable, so you can do whatever you want with it. In the example above, we chose to make the curve hidden (blanked).

Following are some details of the variables that affect the behavior of the dialog:

Argument	Type	Meaning
cue	String	The message displayed in the Cue line
title	String	The title displayed at the top of the dialog
scope	NXOpen.Selection.SelectionScope	The scope of the selection, explained below
keepHighlighted	Boolean	Leave this option set to False. Setting it to True should only be done by advanced users.
typeArray	NXOpen.Selection.SelectionType[]	Select objects from a set of generic types: curves, faces, edges, features, etc.
response	NXOpen.Selection.Result	Response returned from the selection process
selectedObject	NXOpen.TaggedObject	The objects the user selected
cursor	NXOpen.Point3d	Returns the pick point from the selection process

The **cue** and **title** variables are self-explanatory, so we won't discuss them further.

The **scope** argument indicates the domain from which the user will be allowed to select objects. In this case, we have specified that the selection scope should be the work part. The scope options correspond exactly to the choices shown by the Selection Scope menu on the Selection toolbar in interactive NX.

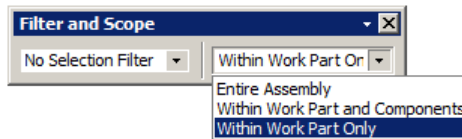

The **typeArray** argument determines what type of object the dialog will allow the user to select. The NX Selection Filter will be pre-set according to the value of the type argument, and this restricts the user to choosing only certain types of objects. There are several other ways of specifying the types of entities that will be eligible for selection. Details are given below.

The **response** object returned by the function indicates how the user interacted with and closed the dialog (whether he clicked OK or Cancel, for example). The function also returns the selection results through two output arguments: the **selectedObject** argument indicates which object was selected, and the **cursor** argument returns the pick point of the selection. You can think of selection as a process of shooting an infinite line (the cursor ray) at your model. The object that gets selected is one that this ray hits, or the one that's closest to the ray. The pick point is the intersection of the cursor ray with your model.

The example code shows the typical process — you normally check the value of the response and then do something to the selected object based on this value.

## Mask Triples

If you need more control over the types of objects that you want to select, you can use the other `SelectTaggedObject` overloaded methods on the Selection object. These methods use mask triples to specific the type of object to be selected. Mask triples are a set of three integers in a structure called `MaskTriple`. The parts of this structure are integers called `Type`, `Subtype`, and `SolidBodySubtype`. The class `NXOpen.UF.UFConstants` contains labeled integer constants used in NX Open and some of these constants are the parts of the mask triple. Usually, you set the `Type` to select a particular type of object, and `Subtype` to select those object of that `Type` that have a particular property. The `Type` and `Subtype` in the mask triple usually correspond with the type and subtype of the object. The `SolidBodySubtype` is usually 0 except for solid geometry types and some other special object types where it represents another detail subtype.

The following table lists the mask triples for some commonly used objects. The `Type` and `Subtype` are the named constants from the `NXOpen.UF.UFConstants` class. These constants are actually defined in the files `uf_object_types.h` and `uf_ui_types.h`, which you can find in `[...NX]\UGOPEN`. In some cases, the constants might be easier to find in these two files, rather than in the `UFConstants` documentation.

Object	Type	Subtype
Point	UF_point_type	0
Line	UF_line_type	0
Circles and Arcs	UF_circle_type	0
Conic - Ellipse	UF_conic_type	UF_conic_ellipse_subtype
Conic - Parabola	UF_conic_type	UF_conic_parabola_subtype
Datum Axis	UF_datum_axis_type	0
Datum Plane	UF_datum_plane_type	0
Spline	UF_spline_type	0
Horizontal Dimension	UF_dimension_type	UF_dim_horizontal_subtype
Vertical Dimension	UF_dimension_type	UF_dim_vertical_subtype
Parallel Dimension	UF_dimension_type	UF_dim_parallel_subtype
Drafting Note	UF_drafting_entity_type	UF_draft_note_subtype
Drafting Centerline	UF_drafting_entity_type	UF_draft_ctrline_subtype

If you wish to select all objects of a particular type, you can use the special value UF\_all\_subtype for the Subtype of the mask triple.

Mask triples for elements of solid or sheet bodies (bodies, faces, and edges) use a type of UF\_solid\_type, a subtype of 0, and use the SolidBodyType to specify the type of the geometry. The following table lists some of the SolidBodySubtype values for different types of geometry on solid or sheet bodies.

Object	SolidBodySubtype
Solid Body	UF_UI_SEL_FEATURE_BODY
Sheet Body	UF_UI_SEL_FEATURE_SHEET_BODY
Any Edge	UF_UI_SEL_FEATURE_ANY_EDGE
Linear Edge	UF_UI_SEL_FEATURE_LINEAR_EDGE
Circular Edge	UF_UI_SEL_FEATURE_CIRCULAR_EDGE
Any Curve or Edge	UF_UI_SEL_FEATURE_ANY_WIRE_OR_EDGE
Any Face	UF_UI_SEL_FEATURE_ANY_FACE
Planar Face	UF_UI_SEL_FEATURE_PLANAR_FACE
Cylindrical Face	UF_UI_SEL_FEATURE_CYLINDRICAL_FACE

You can look at the NXOpen.UF.UFConstants class for a more complete set of values. The values associated with UF\_solid\_type objects all use the prefix UF\_UI\_SEL\_FEATURE, so they are not too difficult to find. Again, if you prefer, you can find the same values in the file `uf_ui_types.h` in `[...NX]\UGOPEN`.

You use different methods from the NXOpen.Selection class to select objects using mask triples. The following code snippet selects lines using a mask triple.

```

Dim theUI = UI.GetUI
Dim selMgr = theUI.SelectionManager
Dim selectedObject As TaggedObject
Dim cursor As Point3d
Dim cue = "Please select a line to be hidden"
Dim title = "Select Lines"
Dim scope = Selection.SelectionScope.AnyInAssembly
Dim action = Selection.SelectionAction.ClearAndEnableSpecific
Dim includeFeatures = False
Dim keepHighlighted = False
Dim lineMask = New Selection.MaskTriple(NXOpen.UF.UFConstants.UF_line_type, 0, 0)
Dim maskArray As Selection.MaskTriple() = { lineMask }
Dim response = selMgr.SelectTaggedObject(cue, title, scope, action,
    includeFeatures, keepHighlighted, maskArray, selectedObject, cursor)

If response <> NXOpen.Selection.Response.Cancel And
    response <> NXOpen.Selection.Response.Back Then
    Dim dispObj = CType(selectedObject, DisplayableObject)
    dispObj.Blank
End If

```

The primary reason to use mask triples over the simpler SelectionType is to allow finer granularity over the types of objects you are selecting. This is illustrated in the following example, where we want to allow the user to select either a circular edge or a cylindrical face (because either of these could represent a hole in a part, perhaps):

```

'MaskTriple for circular edges
Dim type1 = NXOpen.UF.UFConstants.UF_solid_type
Dim subtype1 = 0
Dim solidtype1 = NXOpen.UF.UFConstants.UF_UI_SEL_FEATURE_CIRCULAR_EDGE
Dim edgeMaskTriple = New MaskTriple(type1, subtype1, solidtype1)

'MaskTriple for cylindrical faces
Dim type2 = NXOpen.UF.UFConstants.UF_solid_type
Dim subtype2 = 0
Dim solidtype2 = NXOpen.UF.UFConstants.UF_UI_SEL_FEATURE_CYLINDRICAL_FACE
Dim faceMaskTriple = New MaskTriple(type2, subtype2, solidtype2)

'To select either circular edge or a cylindrical face
Dim maskArray As Selection.MaskTriple() = { edgeMaskTriple, faceMaskTriple }

```

## Selecting a Feature

The method SelectFeatures will display a selection dialog with a list of the features in the work part. You can select a feature from among the feature names in the list, the feature geometry in the graphics region, or the feature node in the Part Navigator. This code snippet shows how to use the method and the following picture shows an example of the feature list dialog.

```

Dim selMgr = UI.GetUI.SelectionManager
Dim cue = "Please select a feature to get info"
Dim featType = SelectionFeatureType.Browsable
Dim featArray() As Features.Feature

Dim resp = selMgr.SelectFeatures(cue, featType, featArray)

If resp <> Response.Cancel And resp <> Response.Back Then
    For Each feat As Features.Feature In featArray
        Guide.InfoWriteLine("Feature Name: " & feat.GetFeatureName)
    Next feat
End If

```

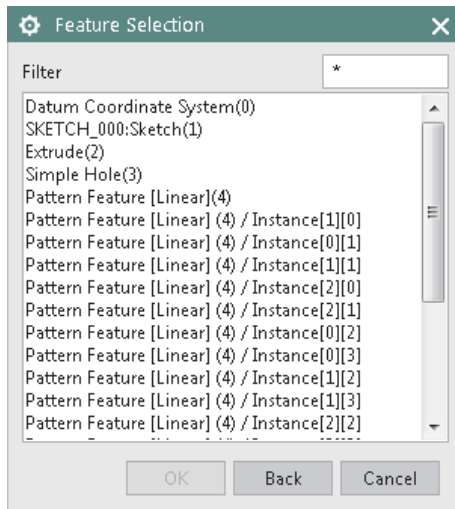

## Specifying a Screen Position

The method `SelectScreenPosition` allows you to prompt the user to pick a location on the graphics display. The coordinates of the point are given by the intersection of the cursor ray of the selection with the X-Y plane of the WCS. The following snippet prints the coordinates of the selected screen location and the view name to the listing window.

```
Dim selManager = UI.GetUI.SelectionManager
Dim cue = "Please select screen position"
Dim theView As View
Dim pt As Point3d

Dim resp = selManager.SelectScreenPosition(cue, theView, pt)

If resp = DialogResult.Pick Then
    Guide.InfoWriteLine(String.Format("Point location: ({0:F3}, {1:F3}, {2:F3})", pt.X, pt.Y, pt.Z))
    Guide.InfoWriteLine("View name: " & theView.Name)
End If
```

## Multiple Selection

So far, the `NXOpen.Selection` methods we have been discussing only let you select one object at a time. There are a set of methods similar to the ones covered above that allow you to select one or more objects in a single selection operation. All the methods allow you to specify the cue, title, and selection scope for the selection and they all return the selected object or objects. The following table summarizes the different selection methods we have been talking about that only select a single object during the selection.

Single SelectionMethod	Filter Selection Argument	Description
<code>SelectTaggedObject</code>	No filtering argument	Selects any type of tagged object.
<code>SelectTaggedObject</code>	<code>Selection.TypeFilter</code> array	Selects an object based on <code>TypeFilter</code> categories
<code>SelectTaggedObject</code>	<code>Selection.SelectionAction</code> , <code>Selection.MaskTriple</code> array	Selects an object based on specific types specific in the <code>MaskTriple</code> array. The <code>SelectionAction</code> argument defines how to apply the filters from the mask triple array to the existing global selection filters in the application.
<code>SelectScreenPosition</code>	<code>Selection.SelectionAction</code> , <code>Selection.MaskTriple</code> array filtering argument	Returns the screen position selection defined as the intersection of the cursor ray with the X-Y plane of the WCS.

The following table summarizes the equivalent methods that allow selecting multiple objects in a single selection:

Multiple SelectionMethod	Filter Selection Argument	Description
SelectTaggedObjects	No filtering argument	Selects one or more tagged objects of any type.
SelectTaggedObjects	Selection.TypeFilter array	Selects one or more objects based on TypeFilter categories.
SelectTaggedObjects	Selection.SelectionAction, Selection.MaskTriple array	Selecting one or more objects based on types specified in the MaskTriple array. The SelectionAction argument defines how to apply the filters from the mask triple array to the existing global selection filters in the application.
SelectFeatures	SelectionFeatureType	Selects one or more features from the features on the work part.

Using these SelectTaggedObjects methods will cause the standard NX multi-selection dialog to appear

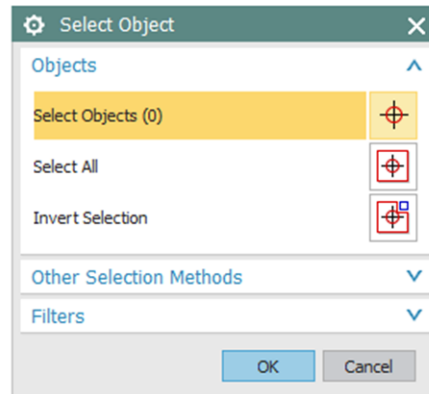

This dialog allows the user to select objects in all the usual ways. As with single selection, the available options in the selection filter will be pre-set to restrict the range of different object types that are selectable.

The selection result is returned in a TaggedObject array that holds all the selected objects. Typically, your code will cycle through this array, doing something to each object in turn. For example:

```

Selection = UI.GetUI.SelectionManager
Dim response = Selection.SelectTaggedObjects(cue, title, scope, action,
    includeFeatures, keepHighlighted, maskArray, objects)
If response <> NXOpen.Selection.Response.Cancel Then
    For Each obj In objects
        Dim dispObj = CType(obj, DisplayableObject)
        dispObj.Blank
    Next
End If

```

You can use standard .NET functions on the array of selected objects. For example, `objects.Length` gives you the number of objects selected, and `objects.ConvertAll` lets you convert it to some other type.

## SelectObject Blocks

Sometimes, you will want to support selection inside a larger block-based dialog, rather than using a standalone selection dialog. To do this, you place a `SelectObject` block on your dialog. As we know from the previous chapter, you use Block UI Styler to create block-based dialogs in NX Open. We'll be creating a simple Block Dialog containing a Select Object block in the example below. The basic steps are as follows:

- You open Block UI Styler
- You add a `SelectObject` block to your dialog
- You adjust the block's characteristics and behavior, if necessary
- You adjust the code generation settings for the dialog
- You save your dialog to a VB file and a dlx file
- You edit the callbacks in the generated VB file to add the behavior for your dialog.



Here are some snippets of the dialog callbacks illustrating the use of `SelectObject` block on a `Block Styler` dialog. We have omitted the class declaration and the `New` method since you should not have to change the code generated from `Block Styler`.

```
Public Sub initialize_cb()  
    selectBlock = CType(theDialog.TopBlock.FindBlock("selectionBlock"), NXOpen.BlockStyler.SelectObject)  
    selectBlock.AddFilter(NXOpen.BlockStyler.SelectObject.FilterTypes.CurvesAndEdges)  
    selectBlock.MaximumScopeAsString = "Entire Assembly"  
End Sub
```

The `MaximumScope` property has type “Enum” when shown in `Block Styler`, but, as you can see, the code above sets its value using a string. The only legal values of the string are “Within Work Part Only”, “Within Work Part and Components”, or “Entire Assembly”. These strings are case sensitive, and spaces do count. You can find the legal string values by looking at the property in `Block Styler`, or by calling the function `GetMaximumScopeMembers`. Using string values to work with `Block Styler` “Enum” properties is a fairly common practice — the `SelectMode` and `StepStatus` properties use the same technique, for example.

```
Public Function apply_cb()  
    Dim selectedObjects As TaggedObject() = selectBlock.GetSelectedObjects  
    Dim selObj = CType(selectedObjects(0), DisplayableObject)  
    selObj.Blank  
    Return 0  
End Function
```

When this code is executed, a small dialog appears, giving the user the opportunity to select a curve or edge:

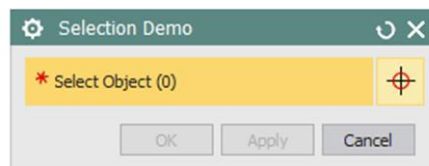

If the user selects a curve and clicks `OK`, the curve will be hidden (blanked). With the filter set to `FilterTypes.CurvesAndEdges`, the user can select edges, too. However, an edge can never be hidden — its visibility is always determined by the visibility of its owning body.

Just as we saw with the `Selection.Dialog` earlier, there is a `SetFilter` function that determines what type of object the block will allow the user to select. Several properties of the `SelectObject` block let you control what type of objects to select. The following table lists some of the `SelectObject` block properties that control selection. More details are in the `Block Styler Reference Guide`. As we saw above, you often use string variables to work with properties that

have type “Enum” in Block Styler. Properties that use this approach are listed as Type “String (Enum)” in the table below:

Property	Type	Meaning
Cue	String	The message displayed in the Cue line
LabelString	String	The prompt string for the Select Object block
MaximumScopeAsString	String (Enum)	Specifies the maximum scope available in Selection Scope on the Selection Bar. Legal string values are: <ul style="list-style-type: none"> <li>• “Within Work Part Only”</li> <li>• “Within Work Part and Components”</li> <li>• “Entire Assembly”</li> </ul>
InterpartSelectionAsString	String (Enum)	Specifies if interpart links are automatically created when selecting geometry from a component. Legal strings are: <ul style="list-style-type: none"> <li>• “Simple”</li> <li>• “Non-associative Interpart Copy Only”</li> <li>• “Associative and Non-associative Interpart Copy”</li> <li>• “Associative Interpart Copy”</li> </ul>
PickPoint	Point3d	Pick point of the selection
PointOverlay	Boolean	If True, adds a button to access the Point Constructor dialog
SelectModeAsString	String (Enum)	“Single” for single selection, “Multiple” for multiple selection
StepStatusAsString	String (Enum)	Defines this selection step to be either “Required” or “Optional”. If set to “Required”, the user must select an object in this block before the OK or Apply buttons become active. The step status is set to “Satisfied” once the user completes a selection.

Several methods allow you to filter the type of objects to select, and to get the objects selected by the user.

Method	Arguments/Return Type	Meaning
AddFilter	SelectObject.FilterType	Specify a general type of object to be selected. Possible types are Components, CurvesAndEdges, Edges, Faces, Features, SheetBodies, and SolidBodies.
AddFilter	Type, Subtype, SolidBodySubtype	Specify one object type from the elements of a mask triple.
GetSelectedObjects	TaggedObject array	Returns the objects selected by the user.
SetSelectionFilter	Selection.SelectionAction, Selection.MaskTriple array	Specify the selection action and the desired types of objects to be selected.

You can use the [AddFilter](#) methods if you just need to select objects from one of the broad categories listed above or from one mask triple type. If you need to select objects from several distinct types, or need more control of the type of object to be selected, use the [SetSelectionFilter](#) method.

After the user has selected some objects, you can retrieve the selected objects using the [GetSelectedObjects](#) method and process them however you wish.

## ■ Selecting Faces, Curves and Edges using Collectors

Most NX features use selection intent rules when selecting faces, curves or edges as input geometry for features. For example, you often will select edges for a blend by picking a given edge while using a selection intent rule to get all edges tangent to the selected edge. You can implement selection intent rules in your block-based dialogs by using special collector blocks to handle face or curve and edge selection. The [CurveCollector](#) block lets you specify a set of selection intent rules for selecting either edges or wireframe curves. The [FaceCollector](#) block lets you specify a set of selection intent rules for selecting faces.

### CurveCollector Block

The [CurveCollector](#) block has some integer properties where the bits of the integer represent options that you can turn on or off by setting that particular bit to 0 or 1. The integer property [CurveRules](#) specifies which curve

selection intent rules should be available for your block. Curve rules that are set to 1 will be added to the Curve Rule drop down menu on the Selection Bar. When your [CurveCollector](#) block is active, the user may select one of these curve selection rules to use for selecting curves. The integer property [EntityTypes](#) specifies which entity types should be selectable by your block. Block UI Styler creates helper variables in the code generated for your dialog to make it easier to set these integer properties. The following tables list some commonly used helper variables that Block UI Styler creates for these properties. A list of curve rules with detailed information is contained in “Selection Intent rules and options on the Top Border bar” in the Fundamentals chapter of the NX documentation.

Curve Rule	Bit Value	Meaning
Body Edges	<a href="#">CurveRules_BodyEdges</a>	Picking any edge from a body will select all the edges of that body.
Connected Curves	<a href="#">CurveRules_ConnectedCurves</a>	Picking a curve will select a chain of end-to-end connected curves that share end points.
Face Edges	<a href="#">CurveRules_FaceEdges</a>	Picking a face will select all the edges of that face, including interior edges for holes in the face
Feature Curves	<a href="#">CurveRules_FeatureCurves</a>	Picking an edge or curve will select all the edges or curves of the feature that owns the selected one.
Single Curve (Required)	<a href="#">CurveRules_SingleCurve</a>	Supports single selection of curves or edges. This rule is required to be on for the CurveCollector block.
Tangent Curves	<a href="#">CurveRules_TangentEdges</a>	Picking an edge or curve will select all the edges or curves tangent to the selected one.

Entity Type	Helper Variable	Meaning
Curves	<a href="#">EntityType_AllowCurves</a>	Filters selection to curves
Edges	<a href="#">EntityType_AllowEdges</a>	Filters selection to edges
Points	<a href="#">EntityType_AllowPoint</a>	Filters selection to existing points
Bodies(Not Used)	<a href="#">EntityType_AllowBodies</a>	<b>Note:</b> this option is generated by Block UI Styler but bodies cannot be directly selected by the CurveCollector.

For example, if you want to select either curves or edges, and use the Single Curve, Tangent Edges, or Vertex Edges rules, you would use the following code in your initialize callback:

```
Public Sub initialize_cb()
    Dim edgeSelect = CType(theDialog.TopBlock.FindBlock("edgeSelectBlock"),
        NXOpen.BlockStyler.CurveCollector)
    edgeSelect.EntityTypes = EntityType_AllowCurves Or EntityType_AllowEdges
    edgeSelect.CurveRules = CurveRules_SingleCurve Or CurveRules_TangentEdges Or
        CurveRules_VertexEdges
End Sub
```

## FaceCollector Block

The [FaceCollector](#) block has some integer properties where the bits of the integer represent options that you can turn on or off by setting the particular bit to 0 or 1. The integer property [FaceRules](#) specifies which face selection intent rules should be available for your block. The integer property [EntityTypes](#) specifies which entity types should be selectable by your block. Block UI Styler creates helper variables in the code generated for your dialog to make it easier to set these integer properties. The following tables list some commonly used helper variables that Block UI Styler creates for these properties. A list of face rules with detailed information is contained in “Selection Intent rules and options on the Top Border bar” in the Fundamentals chapter of the NX documentation.

Face Rule	Bit Value	Meaning
Adjacent Faces	FaceRules_AdjacentFaces	Picking a face will select that face plus the faces adjacent to it.
All Blend Faces	FaceRules_AllBlendFaces	Picking a blend face will select all the faces of the blend.
Body Faces	FaceRules_BodyFaces	Picking any face of a body will select all the faces of that body.
Feature Faces	FaceRules_FeatureFaces	Picking any face of a feature will select all the faces of the feature.
Single Face (required)	FaceRules_SingleFace	Supports single selection of faces. This rule is required to be on for the FaceCollector block.
Tangent Faces	FaceRules_TangentFaces	Picking a face will select all the faces tangent to the selected one.

Entity Type	Helper Variable	Meaning
Datums	EntityType_AllowDatums	Filters selection to datums
Faces	EntityType_AllowFaces	Filters selection to faces
Bodies(Not Used)	EntityType_AllowBodies	<b>Note:</b> this option is generated by Block UI Styler but bodies cannot be directly selected by the FaceCollector.

For example, if you want to select either faces or datums, and use the Single Face, Tangent Faces, or Body Faces rules, you would use the following code in your initialize callback:

```
Public Sub initialize_cb()
    Dim faceSelect = CType(theDialog.TopBlock.FindBlock("faceSelectBlock"),
        NXOpen.BlockStyler.FaceCollector)
    faceSelect.EntityTypes = EntityType_AllowFaces Or EntityType_AllowDatums
    faceSelect.FaceRules = FaceRules_SingleFace Or FaceRules_TangentFaces Or
        FaceRules_BodyFaces
End Sub
```

For more details about selection intent rules, see the “Controlling object selection using the Top Border bar” category of the “Selecting objects” section of the Fundamentals chapter of the NX documentation. For more details about the [CurveCollector](#) and [FaceCollector](#) blocks, look in the Block UI Styler Guide.

## ■ Selection by Database Cycling

Another way to “select” objects is to gather them while cycling through an NX part file. In this case, the selection is done by your code, rather than by the user, but some of the ideas are somewhat similar, so the topic is included in this chapter.

As explained in [chapter 5](#), you can get all the objects of a certain type in a given part file by using various “collection” properties of the `NXOpen.Part` class. For example, the `Curves` collection gives you all the curves in a part file, and the `Bodies` collection gives you all the bodies. You can then cycle through one of these collections using the usual `For Each` construction, doing whatever you want to each object in turn. Often, you will be dealing with the work part, which you can obtain from the Session as `theSession.Parts.Work`. This first example hides all the wire-frame curves in the work part:

```
Dim workPart As NXOpen.Part = theSession.Parts.Work

For Each curve In workPart.Curves
    curve.Blank
Next
```

This next example moves all the sheet bodies in the work part to layer 200:

```
For Each body In workPart.Bodies
  If body.IsSheetBody
    body.Layer = 200
  End If
Next
```

Next, this example assigns color #36 (which is a green color, by default) to each planar face:

```
For Each body In workPart.Bodies
  For Each face In body.GetFaces
    If face.SolidFaceType = NXOpen.Face.FaceType.Planar Then
      face.Color = 36
      face.RedisplayObject
    End If
  Next face
Next body
```

Cycling through **all** of the objects in a part file is a bit more complex. The following code shows one approach. For each object encountered, we write its name (which could possibly be an empty string) to the Info window:

```
Dim ufs = NXOpen.UF.UFSession.GetUFSession
Dim thisObject As NXObject
Dim thisTag As NXOpen.Tag = NXOpen.Tag.Null
Do
  thisTag = ufs.Obj.CycleAll(workPart.Tag, thisTag)
  If thisTag <> NXOpen.Tag.Null Then
    thisObject = NXOpen.Utilities.NXObjectManager.Get(thisTag)
    NXOpen.Guide.InfoWriteLine("Name: " & thisObject.Name)
  End If
Loop Until thisTag = NXOpen.Tag.Null
```

For further information, please refer to the documentation in the NXOpen Reference Guide for the functions [CycleAll](#), [CycleObjsInPart](#), and [CycleTypedObjsInPart](#).

# Chapter 16: Exceptions

Throughout most of this document, we have assumed that all code works without errors, because we did not want error handling issues to complicate the discussion. But in reality, almost all code could potentially run into problems of one sort or another, so proper error handling and recovery is very important. Without it, there is some danger that NX will be left in an unpredictable state.

## ■ Exceptions

When some piece of code encounters a situation that it cannot handle, it must signal this somehow. In modern VB code, an error condition is indicated via an “exception”. We say that the problematic code “raises” or “throws” an exception. Some examples of situations that might cause this to happen are:

- Trying to perform some operation on an object that is [Nothing](#)
- Trying to divide by zero
- Trying to access an array element that is beyond the bounds of the array
- Trying to access a file that doesn’t exist
- Trying to create an NX circle with zero radius

In order for the program to continue, the exception must be handled by the function that encountered it, by the function that calls this function, or by some other higher level function. The exception is passed up the “call stack” from called function to calling function until it is handled. If the exception is not handled anywhere in the call stack, the program will terminate.

The code to handle an exception has the following basic structure:

```
Try
    'Some code that might encounter a problem
Catch ex As System.Exception
    ' Code to react to the problem
End Try
```

So, the code that might encounter a problem is placed in a “Try” block. If a problem arises, an exception is raised, and control is transferred immediately to the “Catch” block, where we insert some code to react to the problem. The exception object is available in the variable named in the Catch statement (the variable “ex” in the example above), so the code within the Catch block can use it.

Your code might include several Catch blocks, each handling exceptions of a specific type. The system examines these Catch blocks in order, looking for one that handles the type of exception that arose. Here are some examples of common types of exceptions, corresponding to the problems listed above:

Exception Type	Thrown when you try to ...
<a href="#">System.NullReferenceException</a>	Perform some operation on an object that is <a href="#">Nothing</a>
<a href="#">System.DivideByZeroException</a>	Divide by zero (with integer variables, anyway)
<a href="#">System.IndexOutOfRangeException</a>	Access an array element that is beyond the bounds of the array
<a href="#">System.IO.FileNotFoundException</a>	Access a file that doesn’t exist
<a href="#">System.StackOverflowException</a>	The system runs out of stack space
<a href="#">NXOpen.NXException</a>	Create an NX circle with zero radius (or thousands of other situations)

This method of dealing with errors is called “structured exception handling”, and it is widely used in modern VB programs, and also in other programming languages, so you can easily find tutorial materials discussing it.

## ■ Example: Unhandled Exceptions

Let's see what happens if our code raises an exception, and we do not handle it. Specifically, let's run the following (ridiculous) code in a few different ways:

```
Module MyCode
    Public Sub Main()
        Dim s1 As String = "hello"
        Dim x1 As Double = Double.Parse(s1)
    End Sub
End Module
```

This code tries to parse a given string and convert it to a Double. This will work fine with a string like "3.14", but it obviously won't work with the string "hello". The example is rather silly, and we can immediately see what the problem is. However, a very similar situation arises if we ask the user to type in a number — there is nothing to stop him (or her) typing "hello", instead of a number, so parsing errors of this type are quite common. If we run this code from the command prompt, here is what happens:

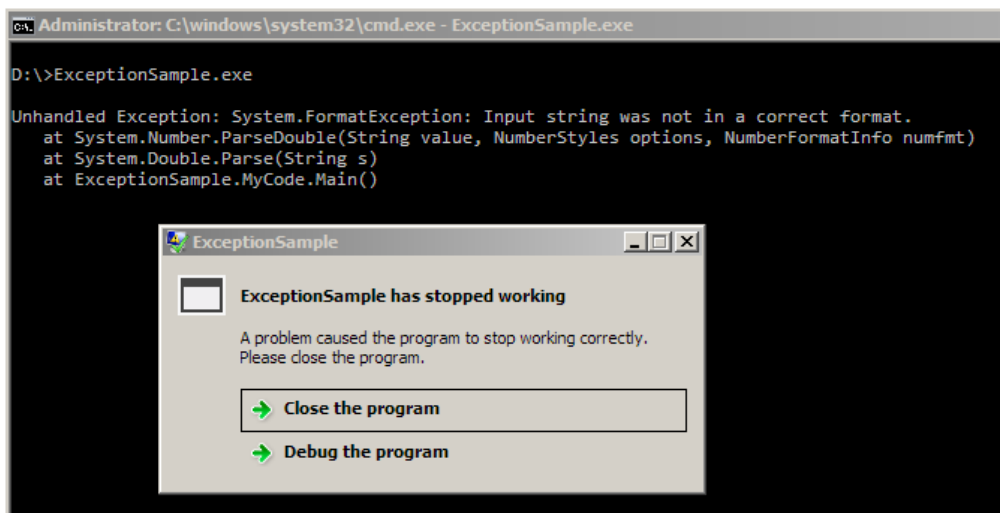

As you can see, the `System.Number.ParseDouble` function raises a `System.FormatException`, complaining that the input string was not in a correct format. The exception is not handled, so it is passed up the call stack to the `System.Double.Parse` function, which again does not handle it. Eventually, the exception reaches our `MyCode.Main` function, where it again goes unhandled, so our program crashes.

The situation is slightly better if we run this code from inside NX using File → Execute. We get the following error:

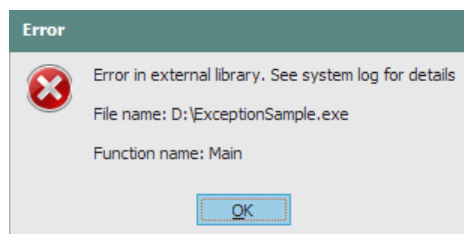

If we look in the system log, we see the following:

```
Caught exception while running: Main
System.FormatException: Input string was not in a correct format.
    at System.Number.ParseDouble(String value, NumberStyles options, NumberFormatInfo numfmt)
    at System.Double.Parse(String s)
    at ExceptionSample.MyCode.Main()
```

This is almost exactly the same sequence of error messages that we saw before. The only difference is that the first line now says that the exception was caught, and did not go unhandled. If we run the same code in the NX Journal Editor, we get a slightly more helpful error message that tells us in which line of code the error occurred:

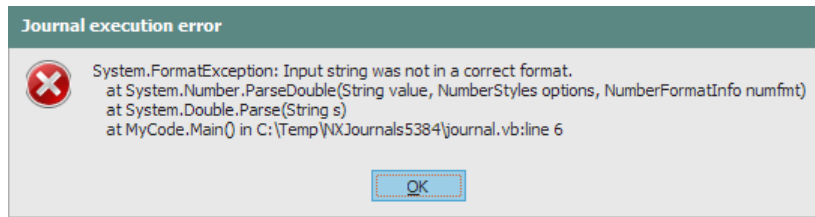

NX provides a high-level mechanism that catches any exception thrown by code run in the Journal Editor or via File→Execute. So, in both cases, the `System.FormatException` was caught by code inside NX, and this prevented NX from crashing.

## ■ Handling an Exception

Next, let's modify our flawed code, and handle the `System.FormatException` ourselves, so that it does not “bubble up” to the high-level exception handling mechanism inside NX. Here is the revised version:

```
Module MyCode
    Public Sub Main()
        Dim s1 As String = "hello"

        Try
            Dim x1 As Double = Double.Parse(s1)
        Catch ex As System.FormatException
            Guide.InfoWriteLine(ex.Message)
            Guide.InfoWriteLine ("Idiot. That string isn't a number.")
        End Try
    End Sub
End Module
```

This code runs without any visible errors, and we get the following output in the NX Info window:

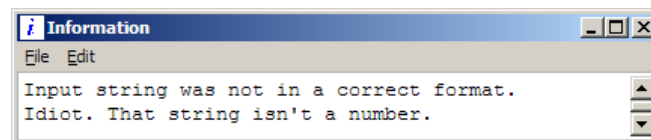

The erroneous call to `Double.Parse` is inside a Try block, so the exception is caught, control passes to our Catch block, and two lines of text are written out to the Info window. The first line is the text from the `Message` property of the exception, and the second line provides some further information about what (probably) went wrong.



## ■ Exception Properties

In the code above, we made use of the [Message](#) property of an Exception. There are some other properties that are also useful, sometimes:

Property	Description
<a href="#">Message</a>	The error message associated with this exception.
<a href="#">InnerException</a>	The Exception instance that caused the current exception.
<a href="#">Source</a>	The name of the application or the object that caused the error.
<a href="#">StackTrace</a>	A string representation of the call stack at the time the exception was thrown.
<a href="#">TargetSite</a>	The method that threw the current exception.
<a href="#">ToString</a>	Returns a string representation of the exception

In practice, the `ToString` function is often the most useful, since it returns a combination of the `Message` and `StackTrace` properties. In the case of the `FormatException` we have been working with, the `ToString` function gives:

```
System.FormatException: Input string was not in a correct format.  
  at System.Number.ParseDouble(String value, NumberStyles options, NumberFormatInfo numfmt)  
  at System.Double.Parse(String s)  
  at MyCode.Main() in C:\Temp\NXJournals5384\journal.vb:line 8
```

We have seen this sort of text before in various error messages, of course — it appears that those error messages might have been constructed just by using the output from the `ToString` function.

## ■ NX Exceptions

The exceptions thrown by NX are all of type `NXOpen.NXException`, which is derived (indirectly) from `System.Exception`. In addition to the general properties of `System.Exception` listed above, an `NXOpen.NXException` has a useful property called `ErrorCode`, which allows us to distinguish one type of error from another. Typically, your code will test the value of the `ErrorCode` property, and branch accordingly. Here is an example that deals with some problems that might arise when creating a circular arc:

```
Dim radius = 1.0      ' Radius  
Dim angle0 = 0.0     ' Start angle (in radians)  
Dim angle1 = 1.0     ' End angle (in radians)  
  
Try  
    workPart.Curves.CreateArc(center, axisX, axisY, radius, angle0, angle1)  
Catch ex As NXOpen.NXException  
    If ex.ErrorCode = 1710021 Then  
        Guide.InfoWriteLine("Radius must be at least 1e-9.")  
        Guide.InfoWriteLine(ex.ToString)  
    ElseIf ex.ErrorCode = 1710014 Then  
        Guide.InfoWriteLine("Angular span must be at least 1e-11 radians.")  
        Guide.InfoWriteLine(ex.ToString)  
    Else  
        Guide.InfoWriteLine("Unknown problem in creating arc.")  
        Guide.InfoWriteLine(ex.ToString)  
    End If  
End Try
```

If we run this code with `radius = 0`, we get the following output:

```
Radius must be at least 1e-9.  
NXOpen.NXException: Invalid Arc Radius.  
  at NXOpen.CurveCollection.CreateArc(Point3d center, Vector3d xDirection, ...)  
  at ExceptionSample.MyCode.Main() in C:\ExceptionSample\MyCode.vb:line 15
```

and if we run it with `angle1 = 0`, we get

Angular span must be at least 1e-11 radians.

NXOpen.NXException: Illegal Arc Length Specified.

```
at NXOpen.CurveCollection.CreateArc(Point3d center, Vector3d xDirection, ...)
at ExceptionSample.MyCode.Main() in C:\ExceptionSample\MyCode.vb:line 15
```

By testing the value of the `ErrorCode`, we can determine what went wrong and provide error messages that are a bit more helpful than “Invalid Arc Radius” or “Illegal Arc Length”.

For a given NX Open function, there is unfortunately no documentation that indicates what values of `ErrorCode` it might return, so you have to discover these by trial and error.

## ■ Using Undo for Error Recovery

In the examples above, we have merely trapped exceptions and reported them. But often this is not enough — we may need to perform some recovery operations to ensure that NX has been returned to a safe and predictable state. The Undo methods in NX Open provide an easy way to do this. Before attempting a risky operation, your code should create an Undo Mark, which will save the current state of NX. If your program encounters an error and needs to recover, you can “roll back” and return NX to this safe saved state. The general approach is as follows:

```
' Create an invisible Undo mark
Dim myMarkName As String = "beginning"
Dim myMark = theSession.SetUndoMark(NXOpen.Session.MarkVisibility.Invisible, myMarkName)

Try
    ' Try something risky (more risky than just creating a sphere, typically)
    Guide.CreateSphere(3,0,0, 1)
    ' It worked, so remove the Undo mark
    theSession.DeleteUndoMark(myMark, myMarkName)
Catch ex1 As NXOpen.NXException
    ' Sphere creation failed, so Undo back to the mark
    theSession.UndoToMark(myMark, myMarkName)
End Try
```

## ■ Avoiding Exceptions

In many cases, it's possible to avoid exceptions. For example, you can often test input data before passing it to a function that might have trouble with certain values. This might improve performance slightly if many exceptions are involved, because raising exceptions is time-consuming. More importantly, removing Try/Catch blocks sometimes makes your code easier to read. In the arc creation shown in the code above, we could have easily avoided the two specific exceptions by writing:

```
If r < 1e-9 Then r = 1e-9 ' Radius must be at least 1e-9
If a1 < 1e-11 Then a1 = 1e-11 ' Angular span must be at least 1e-11
workPart.Curves.CreateArc(center, axisX, axisY, r, a0, a1)
```

Of course, the Try/Catch block will still be needed unless you can anticipate all conceivable problems that might arise when calling the `CreateArc` function.

In some cases, the .NET framework provides functions that are specifically designed to help you avoid exceptions. Failure of the `Parse` function when converting a string to a number (as in our earlier example) is very common, so there is a special `TryParse` function that will not throw an exception if it fails. Similarly, there is a `TryCast` function that you can use instead of `CType`. If the cast fails, `TryCast` returns `Nothing`, rather than raising an exception.

However, there are certain exceptions that are simply unavoidable. For example, when you try to open a file, it may happen that the file does not exist, in which case a `FileNotFoundException` will be raised. You could test to see if the file exists before trying to open it, but even this is not fool-proof – there is some (very small) chance that the file was deleted after you tested but before you opened it.

## ■ The Finally Block

The full form of the Try/Catch construct also includes a “Finally” block, like this:

```
Try
    'Some code that might encounter a problem
Catch ex As Exception
    ' Code to react to the problem
Finally
    ' Cleanup code that must be executed
End Try
```

The code in the Finally block is guaranteed to be executed, unless there is some disaster like a stack overflow or someone unplugging your computer. Specifically, it will be executed even if there is an exception or a Return statement in the Catch block. So, the Finally block is a good place to put cleanup code that must be run to free resources. An example is the code that can be found in the typical Main function that displays a block-based dialog:

```
Public Shared Sub Main()

    Try
        ' Try to create and display a WidgetDialog
        theWidgetDialog = New WidgetDialog
        theWidgetDialog.Show
    Catch ex As Exception
        ' If an exception was raised, display an error message
        Dim theUI = NXOpen.UI.GetUI
        Dim errorType = NXOpen.NXMessageBox.DialogType.Error
        theUI.NXMessageBox.Show("WidgetDialog error", errorType, ex.ToString)
    Finally
        ' Regardless of what happened, free the resources used by the dialog
        theWidgetDialog.Dispose
    End Try

End Sub End Sub
```

The call to the `Dispose` function is needed to ensure that resources used by `theWidgetDialog` are correctly released. By placing this call in the Finally block, we are ensuring that it will be executed regardless of whether an exception occurred or not.

---

# Chapter 17: Troubleshooting

---

This chapter describes a few things that might go wrong as you are working through the examples in this guide, and how you can go about fixing them. If they occur at all, you will probably encounter these problems fairly early in your learning process. But then, once you solve them, they will probably not re-appear, and you should be able to continue your exploration without any further troubles.

## ■ Using the NX Log File

If things go wrong in an NX Open program, you might receive a message like this:

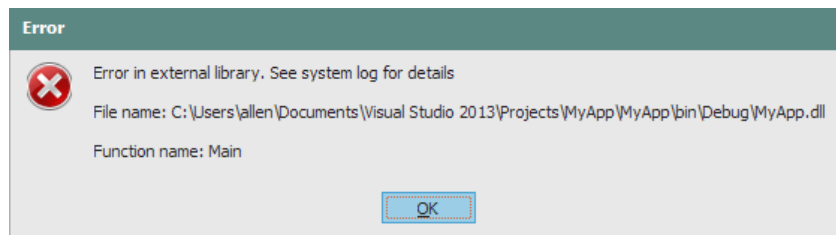

The “external library” is your code, and the message is telling you there’s something wrong with it. The “system log” that the message mentions is the NX Log File (traditionally known as the NX “syslog”), which you can access via the Help → Log File command from within NX. This log file typically contains a large amount of text, some of which can be very useful in diagnosing problems. After an error, the useful information is usually at the bottom of the syslog, so you should start at the end and work backwards in your search for information. The typical text, about a dozen lines from the end of the syslog, will look something like this:

```
Caught exception while running: Main
NXOpen.NXException: Attempt to use an object that is not alive
  at NXOpen.TaggedObject.get_Tag()
  at NXOpen.DisplayableObject.Blank()
  at MyApp.MyProgram.Main() in c:\users\yamada\Projects\MyApp\MyApp\MyProgram.vb:line 13
```

I deliberately caused this error by deleting an object and then trying to “Blank” it (make it hidden). As you can see, NX is quite rightly complaining that I am attempting to use an object that is no longer alive, and this caused the `get_Tag` function to fail. The syslog text is quite helpful here, as is often the case. When things go wrong, it’s usually a good idea to look at the messages near the end of the syslog, to see if there is any useful information.

## ■ Invalid Attempt to Load Library

To use NX Open, you need to have a fairly recent version of the .NET Framework installed on your computer. It’s OK to have earlier versions, too, in addition to the necessary newer ones — the different versions won’t conflict with one another. For any version of NX, the Release Notes document lists the required version; NX 12 requires .NET Version 4.6, for example. If you don’t have the correct .NET version installed, then, the first time you try to run any code in the Journal Editor, you will receive this mysterious error message

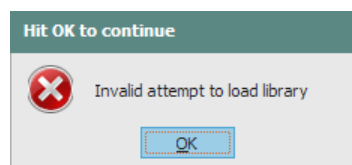

If you look in the NX syslog, you will find that it says:

```
Journal execution results...
Error loading libraries needed to run a journal.
```

To fix this problem, you just need to install the necessary version of the .NET Framework. To check which version(s) you have already, look in your Windows\Microsoft.NET\Framework folder, or use the “Programs and Features” Control Panel. If you don’t have the correct version, please download it from this Microsoft site and install it on your system. If you find that the link to the Microsoft site is broken, you can easily find the download by searching the internet for “.NET Framework”.

## ■ **XXX is not a member of NXOpen**

When writing code in Visual Studio, you may encounter an error message saying that something “is not a member of NXOpen”. In a typical NX Open program that begins with getting the NXOpen.Session object, this is what will cause the error, so the message will say “Session is not a member of NXOpen”.

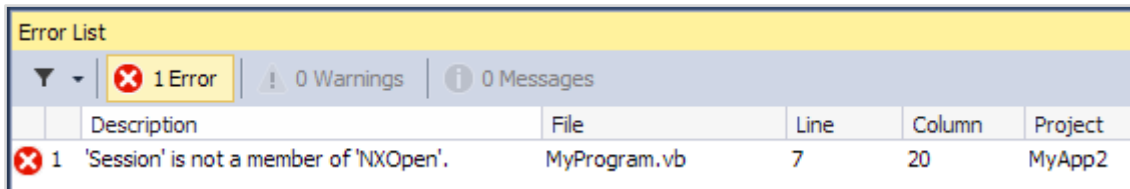

If you run into this problem at all, it will probably be the first time you try to build an NX Open application in Visual Studio. It arises because your code is using the NXOpen library, and this is not connected in any way to your current project. The message is misleading — Session certainly *is* a member of NXOpen, as we well know, but the compiler doesn’t know anything about NXOpen, so it complains.

For confirmation, look in the References folder in the Solution Explorer pane (usually in the upper right of the Visual Studio window). If you don’t see NXOpen listed there, then this explains the problem. This situation could arise because you used some generic template (rather than an NXOpen template) to create your project, as we described in example 4 in chapter 3. Fortunately, this problem is easy to fix. From the Project menu, choose Add Reference. In the dialog that appears, click on the Browse tab, and navigate to the [...NX]\NXBIN\managed folder:

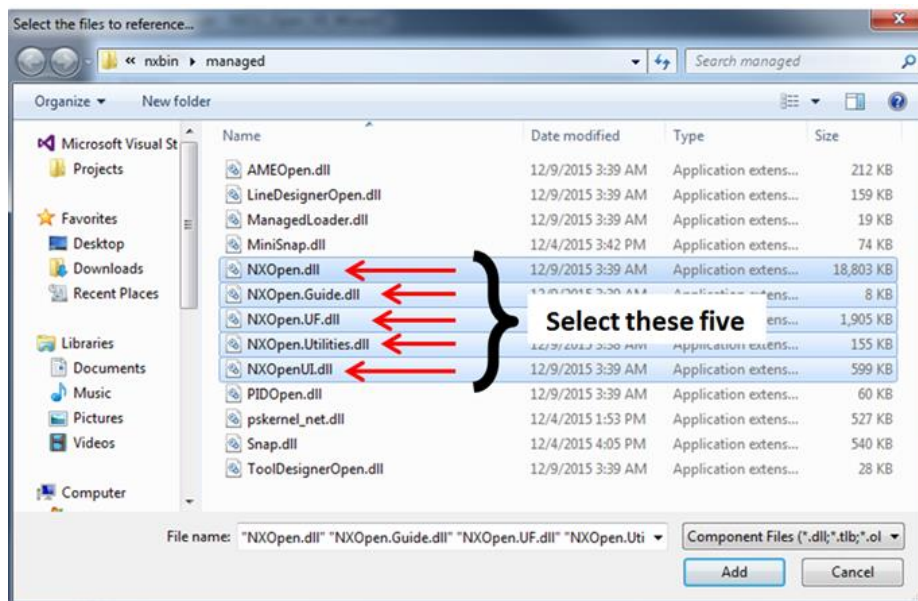

Select the five needed DLLs, as shown above, and click OK. Your project now has references to the NX Open libraries, and this should stop the complaints.

This problem will happen only when using Visual Studio. When you run code in the Journal Editor, referencing of the various NX/Open libraries is all handled inside NX, so it’s not likely to go wrong.

## ■ Unable to Load Referenced Library

Maybe your project includes references to the NX Open libraries, but these references are “broken” (pointing to the wrong locations). You can confirm this by looking in the References folder in Solution Explorer, again. The little yellow triangular “caution” signs indicate broken references:

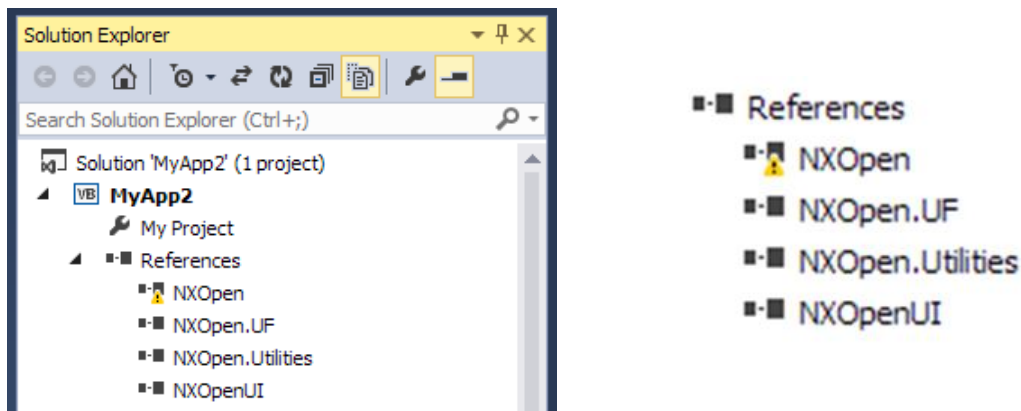

In this case, you will receive error messages like this when you build your project:

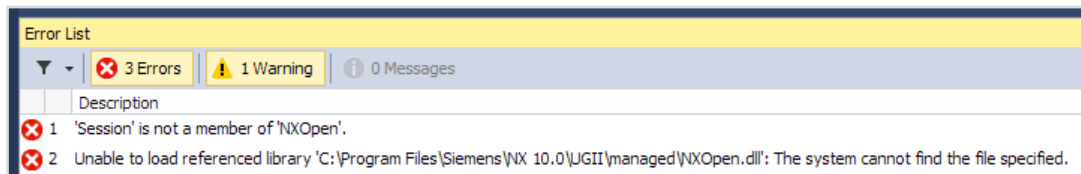

To fix the problem, you have to delete the broken references and create new ones. Right-click on each reference in Solution Explorer, and choose “Remove”. Then create new references as described in the previous section.

The NX Open application templates use the `UGII_BASE_DIR` environment variable to establish the references, so, if this environment variable is set incorrectly, you’ll get annoying broken references in every project you create.

## ■ Visual Studio Templates Missing

When you start working through the examples in chapter 3, you may find that the NX Open project templates (`NXOpenTemplateVB, xxx`) are not listed in the “New Project” dialog in Visual Studio. There are a few possible causes for this problem. First, maybe you forgot to copy the template zip files, as instructed near the beginning of chapter 3. You can find the three necessary zip files in the folder `[...NX]\UGOPEN\xxx\Templates`. You need to copy these three files into the folder `[My Documents]\[Visual Studio]\Templates\ProjectTemplates\Visual Basic`.

You may find other folders with names like `C:\Program Files\Microsoft Visual Studio\Common\IDE\Templates` if you hunt around your disk. None of these are the correct destination for the `NXOpen` templates, despite the unfortunate similarity of names.

Finally, despite the warning in big red letters in chapter 3, maybe you unzipped the three zip files. You should not do this — Visual Studio cannot use them if they are unzipped.

## ■ Failed to Load Image

The “Failed to Load Image” error usually occurs because there is a mismatch between the type of your NX installation and the type of NX Open application you created. Specifically, you will get this error if you have a 64-bit version of NX but you try to run a 32-bit NX Open application. From NX 10 onwards, all versions of NX are 64-bit.

When you try to run your NX Open application, you will get this error:

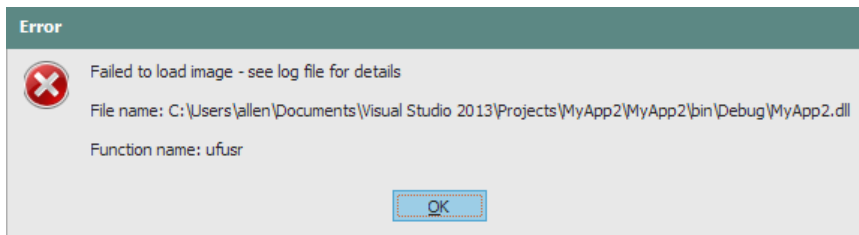

If you look in the NX syslog, will find something like this:

The reason ...MyApp2.dll failed to load was:  
Cannot classify image \MyApp2\bin\Debug\MyApp2.dll

Again, this indicates that 64-bit NX was unable to load and run your application because it was built for a 32-bit architecture. With the full version of Visual Studio, you can avoid this problem by specifying what type of application you want to build. Choose Project → Properties, and set the Target CPU to x64 (not x86 or AnyCPU), as shown below:

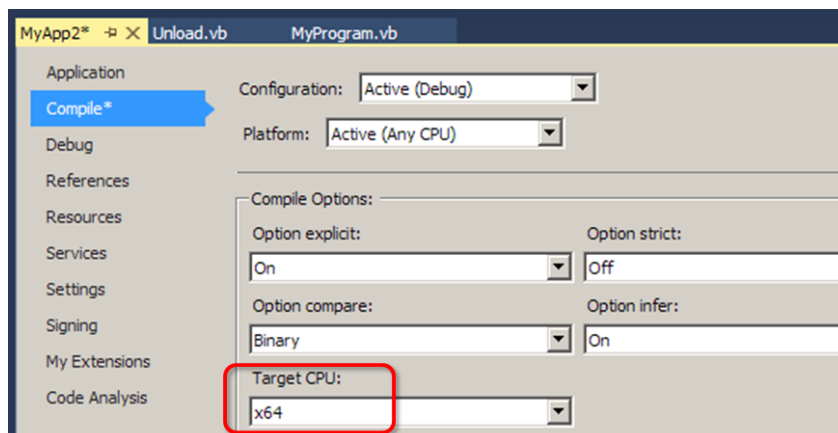

In Visual Studio Express, there is less flexibility in this area, so you have to be careful to base your projects on the right type of template. With some of the Visual Studio “Console Application” templates, the default target is x86 or AnyCPU, so you will run into problems if you are using a 64-bit version of NX. If you always use the NXOpen project templates we provide, then things should go smoothly.

## That's All Folks

This seems like a strange way to end our tour of NX Open, but having a separate “wrap up” chapter would be even more ridiculous, so we’ll just stop here. We hope this introduction has been useful to you, and that you will want to explore NX Open further. As we have told you many times before, you can find out (much) more about the details of the available functions by consulting the NX Open Reference Manual. Bon voyage!

---

# Appendix: Guide Functions

---

Here we describe a few “helper” functions that are intended to make the example code in this document shorter and easier to understand. Since their only purpose is to improve the readability of this guide, we call them [Guide](#) functions. For instance, our example code often uses sphere features to illustrate some concept. Rather than repeating the dozen or so lines of code required to create a sphere, we have captured that code in the simple [Guide.CreateSphere](#) function shown below.

The functions are very simple and limited. For example, they create “dumb” curves, rather than associative ones, and they don’t use expressions. The goal was to make the functions easy to understand and easy to call. Though you may find uses for them in the code you write, their intended purpose is purely expository.

The descriptions below are provided here just for convenience. The Guide functions are also described in the NX Open Reference Guide, of course.

## ■ InfoWrite

Writes a string to the Info window (with no newline added)

[InfoWrite\(info As String\)](#)

Parameter	Type	Description
<a href="#">info</a>	<a href="#">String</a>	The string you want to write

## ■ InfoWriteLine

Writes a string to the Info window (with a newline added)

[InfoWriteLine\(info As String\)](#)

Parameter	Type	Description
<a href="#">info</a>	<a href="#">String</a>	The string you want to write

## ■ CreatePoint

Creates an NXOpen.Point object

[CreatePoint\(x As Double, y As Double, z As Double\) As Point](#)

Parameter	Type	Description
<a href="#">x</a>	<a href="#">Double</a>	x coordinate
<a href="#">y</a>	<a href="#">Double</a>	y coordinate
<a href="#">z</a>	<a href="#">Double</a>	z coordinate
Return	<a href="#">NXOpen.Point</a>	The point that was created

## ■ CreateLine

Creates an NXOpen.Line object

[CreateLine\(x0 As Double, y0 As Double, z0 As Double, x1 As Double, y1 As Double, z1 As Double\) As Line](#)



Parameter	Type	Description
x0	Double	X-coordinate of start point of line
y0	Double	Y-coordinate of start point of line
z0	Double	Z-coordinate of start point of line
x1	Double	X-coordinate of end point of line
y1	Double	Y-coordinate of end point of line
z1	Double	Z-coordinate of end point of line
Return	NXOpen.Line	The line that was created

## ■ CreateCircle (Double, Double, Double, Double)

Creates a circle parallel to the XY-plane

CreateCircle(cx As Double, cy As Double, cz As Double, radius As Double) As Arc

Parameter	Type	Description
cx	Double	X-coordinate of center point (in absolute coordinates)
cy	Double	Y-coordinate of center point (in absolute coordinates)
cz	Double	Z-coordinate of center point (in absolute coordinates)
radius	Double	Radius
Return	NXOpen.Arc	The arc that was created

## ■ CreateCircle (Point3d, Vector3d, Double)

Creates a circle from center, normal, radius

CreateCircle(center As Point3d, axisZ As Vector3d, radius As Double) As Arc

Parameter	Type	Description
center	Point3d	Center point (in absolute coordinates)
axisZ	Vector3d	Unit vector normal to plane of circle
radius	Double	Radius
Return	NXOpen.Arc	The arc that was created

## ■ Unite

Unites two bodies to create a boolean feature

Unite(target As NXOpen.Body, tool As NXOpen.Body) As NXOpen.Features.BooleanFeature

Parameter	Type	Description
target	NXOpen.Body	The target body (a solid body)
tool	NXOpen.Body	The tool body (a solid body)
Return	NXOpen.Features.BooleanFeature	The boolean feature that was created

## ■ CreateSphere

Creates a sphere feature, given center coordinates and diameter

`CreateSphere(cx As Double, cy As Double, cz As Double, diameter As Double) As Sphere`

Parameter	Type	Description
<code>cx</code>	<code>Double</code>	X-coordinate of center point
<code>cy</code>	<code>Double</code>	Y-coordinate of center point
<code>cz</code>	<code>Double</code>	Z-coordinate of center point
<code>diameter</code>	<code>Double</code>	The diameter of the sphere
Return	<code>NXOpen.Features.Sphere</code>	The sphere feature that was created

## ■ CreateCylinder

Creates a cylinder feature, given its base point, axis vector, diameter, and height

`CreateCylinder(origin As Point3d, axis As Vector3d, diameter As Double, height As Double)`

Parameter	Type	Description
<code>origin</code>	<code>Point3d</code>	Point at center of base of cylinder
<code>axis</code>	<code>Vector3d</code>	A vector along the centerline of the cylinder
<code>diameter</code>	<code>Double</code>	The diameter of the cylinder
<code>height</code>	<code>Double</code>	The diameter of the cylinder
Return	<code>NXOpen.Features.Cylinder</code>	The cylinder feature that was created

## ■ CurvePoint

Calculates a point on a curve at a given parameter value

`CurvePoint(curve As Curve, t As Double) As Point3d`

Parameter	Type	Description
<code>curve</code>	<code>NXOpen.Curve</code>	The curve
<code>t</code>	<code>Double</code>	The parameter value
Return	<code>NXOpen.Point3d</code>	The position on the curve at the given parameter value

## ■ CurveTangent

Calculates a unit tangent vector on a curve at a given parameter value

`CurveTangent(curve As Curve, t As Double) As Vector3d`

Parameter	Type	Description
<code>curve</code>	<code>NXOpen.Curve</code>	The curve
<code>t</code>	<code>Double</code>	The parameter value
Return	<code>NXOpen.Vector3d</code>	Unit tangent vector at location on curve